



# BASIC THEORY OF DRIVING THE OFFICIAL HANDBOOK



# BASIC THEORY OF DRIVING

THE OFFICIAL HANDBOOK

## CONTENTS

### PART A : DRIVING LICENCES

Introduction	3
What Is A Driving Licence?	3
Fitness To Drive	3
Classes Of Driving Licences	3
Test Of Competence To Drive	4
Provisional Driving Licence (PDL)	4
Validity Of Driving Licence	4
'NEW' Drivers	5
Driver Improvement Points System (DIPS)	5
Medical Examination	7
Online Portals	8

### PART B (to be tested during Basic Theory Test)

#### SIGNS AND SIGNALS

Mandatory Signs	9
Prohibitory Signs	11
Warning Signs	14
Regulatory Signs	19
Information Signs	21
Pedestrian Crossing Signs	24
Traffic Signs For Tunnels	25
Signs For Pedal-Cycles	26
Directional Signs	27
Expressway Monitoring And Advisory System (EMAS)	29
Facility Signs	34
Vehicle Markings	34
Common Road Markings	35
Direction Arrows	43
Merging Arrow Markings	43
Signals (Traffic Lights)	44
Signals (On The Road)	46
Signals Given By A Police Officer	47
Hand Signals	49

#### TRAFFIC RULES AND REGULATIONS

The Keep-Left Rule	50
Lane Discipline	50
Overtaking	50
Road-Hogging	52
Speed Limits	52
The 'Give Way' Rule At Road Junctions	52
Roundabouts	53
Driving On Expressways	54
Yellow-Box Junctions	54
U-Turns	56
Stopping And Parking	56
Seat Belts	57
Lights	57
Alcohol	58
Light Goods Vehicles	58

Basic Theory of Driving is published by  
© Singapore Traffic Police.

No part of this publication may be reproduced, stored in a retrieval system, or transmitted in any form or by any means, electronic, mechanical, photocopying, recording or otherwise, without the prior permission of the publisher:

#### Singapore Traffic Police

10 Ubi Avenue 3  
Singapore 408865  
T (65) 6547 0000  
F (65) 6547 4900

Published online by  
© Singapore Traffic Police

Last updated on 22.2.2024

Note: The information contained in this handbook is accurate at the time of publication. Candidates are advised to log in to the TP website at <https://www.police.gov.sg> & LTA website at <https://www.lta.gov.sg> for the latest updates.

## CONTENTS

---

Height Limits	58
Use Of Mobile Communication Device While Driving	59
<b>CODE OF CONDUCT ON THE ROAD</b>	
Moving Off	60
Mirrors And Signals	60
Driving Along	60
Tailgating	60
Safe Following Distance	60
The 'Two-Second' Rule	61
Stopping Distance	61
Reversing	62
Safety Of Pedestrians And Cyclists	62
Emergency Vehicles	62
General Safe Driving	62
Safe Driving Technique (Defensive Driving Technique)	65
Stopping And Moving Off At Traffic Light Junctions	70
Roadworthiness	70
<b>PARTS AND CONTROLS OF A CAR</b>	
Front View/Rear View	71
The Instrument Panel (Dashboard)	72
Names Of Various Driving Controls	72
<b>WORK ZONES</b>	
Road Users At Work Zones	73
Work Zone Signs	73
<b>DRIVING IN SPECIAL ZONES</b>	
School Zone Safety	75
Driving In School Zones	75
Silver Zone Safety	75
Driving In Silver Zone	76
<b>DRIVING IN TUNNELS</b>	
Daily Driving Rules	76
<b>AUTONOMOUS VEHICLE</b>	
Introduction	77
How to recognise an Autonomous Vehicles on trial?	77
How to interact with an Autonomous Vehicle on trial?	77
<b>ELECTRIC MOTORCYCLE</b>	
Introduction	78
Features of electric motorcycle	78
Classes of Driving License for Electric Motorcycle	78
<b>PART C (USEFUL INFORMATION)</b>	
<b>PARKING IN URA/HDB CAR PARKS</b>	79
<b>LANE USE AND VARIABLE MESSAGE SIGNS (LUS)</b>	82
Emergency Facilities (Tunnels)	82
Emergency/Incident Procedures (Tunnels)	83
<b>ECO-DRIVING: WAYS TO SAVE FUEL AND SAVE THE ENVIRONMENT</b>	
Introduction	83
What is ECO-driving?	85
How to adopt ECO-driving?	85
<b>SECURITY MEASURES TO PREVENT THEFT OF/ FROM MOTOR VEHICLES</b>	
Introduction	87
Motorcycles	87
Cars	87
General	87
<b>KEY POINTS OF THE MOTOR CLAIMS FRAMEWORK (MCF)</b>	88



# PART A DRIVING LICENCES

## INTRODUCTION

The “Basic Theory of Driving” handbook is essential reading for all road users in Singapore, which comprise the pedestrians, cyclists, motorcyclists and drivers. It covers The Highway Code, which includes the traffic rules, traffic regulations, traffic signs and signals, and it aims to educate and promote road safety for the road users. Many of the rules and regulations in the Code are legal requirements, and if you disobey them, you are committing a traffic offence. You may be fined and given demerit points on your driving licence, which may lead to suspension or revocation of your driving licence, or you may be disqualified by the Courts from driving. Knowing and applying the traffic rules and regulations in The Highway Code could significantly help to reduce road accidents, casualties and fatalities on our roads.

## WHAT IS A DRIVING LICENCE?

- 1 A driving licence is a legal document issued by the Traffic Police under the Road Traffic Act, which identifies the licensee, sets out the class(es) of vehicle(s) which he/she may legally drive and states such restrictions or conditions as may apply as well as the period for which the licence is valid, where applicable.

## FITNESS TO DRIVE

- 2 In order to qualify for a driving licence to drive or ride a motor vehicle on the roads in Singapore, an applicant:
  - (i) Must be at least 18 years old;
  - (ii) Must have passed the test of competence to drive;
  - (iii) Must not be suffering from mental disorder;
  - (iv) Must not be suffering from epilepsy;
  - (v) Must not be liable to sudden attacks of disabling giddiness or fainting;
  - (vi) Must be able to read at a distance of 25 metres (with the aid of glasses, if worn) a series of 6 letters and figures in white on a black background of the same size and arrangement as those prescribed for the identification mark of a motor vehicle; and
  - (vii) Must be able to distinguish the colours red, amber and green from a distance of 25 metres.

## CLASSES OF DRIVING LICENCES

- 3 The following table is a list of classes of driving licence granted by the Traffic Police under the law.

	DESCRIPTION	ELIGIBILITY
Class 1	Invalid carriage of unladen weight not exceeding 250 kg and which are specially designed and constructed, and not merely adapted, for the use of persons suffering from some physical defect or disability and are used solely by those persons.	Invalids or those suffering from some physical defect or disability who are 18 years old and above.
Class 2B	Motor cycles with an engine capacity not exceeding 200 c.c., or motor cycles which are propelled by electric motor with a power output not exceeding 15kw and registered as motorcycles.	Be at least 18 years old.
Class 2A	Motor cycles with an engine capacity between 201 c.c and 400 c.c. and motor cycles propelled by an electric motor with a power output between 15.1kw and 25kw.	Be in possession of a class 2B Qualified Licence for at least one year.
Class 2	Motor cycle with an engine capacity exceeding 400 c.c. and motor cycle propelled by an electric engine with a power output exceeding 25kw.	Be in possession of a class 2A Qualified Licence for at least one year.
Class 3	Motor cars/ Ambulances of an unladen weight not exceeding 3000 kg with not more than 7 passengers, exclusive of the driver; and motor tractors / vehicles of unladen weight not exceeding 2500 kg.	Be at least 18 years old.
Class 3A	Motor cars without clutch pedals (auto) of an unladen weight not exceeding 3000 kg with not more than 7 passengers, exclusive of the driver; and motor tractors / vehicles without clutch pedals of unladen weight not exceeding 2500 kg.	Be at least 18 years old.
Class 3C	Motor cars constructed solely and adapted to carry not more than 7 passengers (exclusive of the driver) and the weight of which unladen does not exceed 3000 kg only.	Work Permit and S-pass holders only need to pass the Basic Theory Test to convert their foreign driving license to be allowed to drive all Class 3 vehicles except for light goods vehicles, mini vans and small buses.
Class 3CA	Motor cars without clutch pedals of unladen weight not exceeding 3000 kg with not more than 7 passengers exclusive of the driver.	The Class 3CA licence is introduced to new drivers who only want to drive automated Class 3C vehicles.

<b>Class 4A</b>	Omnibuses - For public service vehicles which are used on scheduled services and in which passengers are charged separate and distinct fares.	Be at least 21 years old and in possession of a class 3 Qualified Licence.
<b>Class 4</b>	Heavy motor cars of an unladen weight exceeding 2500 kg and constructed to carry a load or passengers; and motor tractors of an unladen weight between 2500 kg and 7250 kg.	Be at least 21 years old and in possession of a class 3 Qualified Licence.
<b>Class 5</b>	Motor vehicle of an unladen weight exceeding 7250 kg and not constructed to carry any load.	Be at least 21 years old and in possession of a class 4 Qualified Licence.

## TEST OF COMPETENCE TO DRIVE

- 4 An applicant for a new class of licence must pass the test of competence to drive, which includes the theory and/or practical driving/riding tests:
- (a) **Basic Theory Test (BTT)**  
The Basic Theory Test (BTT) is designed to test your knowledge of the traffic rules, traffic regulations, traffic signs and signals as well as general road safety. The testing curriculum for BTT is broadly covered in the handbook titled “The Official Handbook - Basic Theory of Driving” and all learner drivers and riders must obtain a pass for BTT before they can proceed to take the advanced theory test i.e. the Final Theory Test (FTT) or the Riding Theory Test (RTT).
- (b) **Final Theory Test (FTT)**  
After passing the BTT, and if you want to obtain a motorcar driving licence (Class 3 or 3A), you must pass your FTT before you can take the Practical Driving Test. The FTT aims to test your knowledge on driving safety aspects and proper techniques of driving, as well as your interaction with other road users whilst driving on the roads. After you have passed your FTT, you are required to pass the Practical Driving Test within two years, failing which, you will have to retake and pass your FTT again before you can apply for another Practical Driving Test. The testing curriculum for FTT is broadly covered in the handbook titled “The Official Handbook - Final Theory of Driving”.
- (c) **Riding Theory Test (RTT)**  
After passing the BTT, and if you want to obtain a motorcycle driving licence (Class 2B), you must pass your RTT before you can take the Practical Riding Test. The RTT aims to test your knowledge on riding safety aspects and proper techniques of riding, as well as your interaction with other road users whilst riding on the roads. After you have passed your RTT, you are required to pass the Practical Riding Test within one year, failing which, you have to retake and pass your RTT again before you can apply for another Practical Riding Test.
- (d) **Practical Driving / Riding Test**  
The Practical Driving / Riding Test will be conducted by a Driving Examiner appointed by the Traffic Police. You must provide a motor vehicle which is suitable for the test, in good mechanical condition and properly insured against third-party risks.
- 5 In order to book and take a theory or practical driving / riding test, an applicant must fulfil the following eligibility requirements at the date of booking or date of taking his/her test:
- (a) He/She has not accumulated more than 12 demerit points;
- (b) He/She is not under suspension or Court disqualification or is not within the period of one year from the date of revocation of his/her driving licence;
- (c) He/She is not under police investigation; and
- (d) He/She has not committed 2 or more offences of failing to display a distinguishing mark (i.e. Probation Plate) during his/her period of probation as a new driver for his/her other new class of driving licence.

## PROVISIONAL DRIVING LICENCE (PDL)

- 6 After passing your BTT, you may apply for a Provisional Driving Licence (PDL) to start learning to drive or ride on the roads with your driving instructor. A PDL is valid for 2 years from the date of grant and can be renewed subsequently for every 2 years.
- 7 As a PDL holder, you must display two 18 cm square ‘L’ plates, in a conspicuous position on both the front and back of your motor vehicle during your driving lessons and driving tests, as well as be insured against third-party risk, during your driving tests and driving lessons. You can only drive whilst under the supervision of your licensed driving instructor or driving school’s driving instructor.
- 8 To apply for a PDL, an applicant must fulfil the following eligibility requirements at the date of the application:
- (a) He/She has not accumulated more than 12 demerit points;
- (b) He/She has passed his/her BTT;
- (c) He/She must be able to read at a distance of 25 metres (with the aid of glasses, if worn) a series of 6 letters and figures in white on a black background of the same size and arrangement as those prescribed for the identification mark of a motor vehicle; and
- (d) He/She must be able to distinguish the colours red, amber and green from a distance of 25 metres.

## VALIDITY OF DRIVING LICENCE

- 9 If you are a Singapore Citizen or a Permanent Resident, your driving licence will be valid for your lifetime. However, if you are a foreigner and a holder of a work pass granted by the Ministry of Manpower (for example: Employment Pass, S-Pass, Work Permit, Dependent Pass issued with restriction as to his/her period of stay in Singapore), your driving licence will be valid for a period up to 5 years.

## PART A

### DRIVING LICENCES

---

#### 'NEW' DRIVERS

- 10** New drivers are motorists who hold a new class of driving licence for less than one year from the date of grant of licence. They shall be under probation for one year from the date of grant of the new driving licence to them.
- 11** During the one year probation period, all new Class 2B, Class 3/3A and Class 3C/3CA drivers are required to display a distinguishing mark (i.e. Probation Plate) at the front and rear of their vehicles when driving.

In the case of a Class 2B motor vehicle, the Probation Plate should be displayed:

- (a) directly above or below the headlamp; and
- (b) directly above or below the rear licence plate.

For a Class 3, 3A, 3C & 3CA motor vehicle which is constructed with a front and a rear windscreen, the Probation Plate should be displayed;

- (a) at the top right portion of the front windscreen; and
- (b) at the top right portion of the rear windscreen, as seen from the outside of the vehicle;



Probation Plate

- 12** Those who fail to display the Probation Plate will be fined. Repeat offenders with at least 2 offences of failing to display the Probation Plate during their one year probation period will have their licence revoked.

A new driver who accumulates 13 or more demerit points during the one year probation period will also have his/her new driving licence revoked.

#### DRIVER IMPROVEMENT POINTS SYSTEM (DIPS)

- 13** Singapore's demerit points system, named the Driver Improvement Points System (DIPS), was introduced on 1 March 1983.
- 14** DIPS is designed to identify and rehabilitate errant drivers through a system of rewards and punishments. Errant motorists are thus encouraged to improve their driving behaviours on the roads with incentives to expunge their demerit points and previous suspension record as well as remission of suspension period.

##### Key Features Of DIPS

##### Suspension Of Driving Licence

###### New or Probationary Motorists

- 15** For a new motorist who is under one year probation from the date of grant of his/her driving licence, his/her new driving licence will be revoked and become invalid when he/she accumulates 13 or more demerit points during his/her probation period. The licence holder will have to retake all the necessary driving tests (theory and practical) to obtain a licence to drive/ride again and can only retake the driving tests one year after the revocation is effected.

###### Non-Probationary Motorists

- 16** For a motorist who has no previous suspension record with Traffic Police, if he/she has accumulated 24 or more demerit points within 24 consecutive months, his/her driving licence will become liable for the 1st suspension of a period of 12 weeks.
- 17** For a motorist who has previous suspension records with Traffic Police, if he/she has accumulated 12 or more demerit points within 12 consecutive months, his/her driving licence will become liable for the subsequent suspension.
- 18** For subsequent suspensions after the 1st suspension, the suspension periods are:
- (a) 2nd suspension : 24 weeks;
  - (b) 3rd suspension : 1 year;
  - (c) 4th suspension : 2 years; and
  - (d) 5th suspension (onwards) : 3 years.
- 19** Where the suspension period is a year or longer (i.e. 3rd suspension onwards), the driving licence will be revoked and become invalid. The licence holder will have to retake all the necessary driving tests (theory and practical) to obtain a licence to drive/ride again. Traffic Police takes a firm stance against motorists who commit traffic violations or drive while under suspension or revocation.
- 20** Motorists who wish to appeal for their traffic offences can only do so online via TP's e-Appeals Portal. Appeals for traffic offences will only be considered on grounds of extenuating circumstances, such as medical emergencies, and must be supported by relevant documentary proof. Repeated appeals without fresh evidence will not be considered.
- 21** Motorists liable for 1st and 2nd suspensions will be offered a retraining course to correct their driving behaviour. If they take and pass the retraining course, they will be given a remission on their suspension period:
- (a) For 1st suspension, the suspension period will be reduced from 12 weeks to 4 weeks. If none of their traffic offences leading to their 1st suspension was involved in a traffic accident, their suspension period will be further reduced to 1 week; and
  - (b) For 2nd suspension, it will be reduced from 24 weeks to 12 weeks.
- 22** There is no offer of retraining course and remission for 3rd and subsequent suspensions.

## PART A

### DRIVING LICENCES

- 23 During the suspension period, the licence holder's photocard driving licence must be surrendered to Traffic Police. For 1st and 2nd suspensions, the licence holder's photocard driving licence will be returned to him/her upon the expiry of the suspension period.

The following table summarises the suspension rules under DIPS for non-probationary motorists.

Level Of Suspensions	Criteria for Suspension	Period of Suspension	Maximum Remission Allowed	Balance Period Of Suspension After Retraining
1st suspension	24 points or more within 24 months	12 weeks	8 weeks (after passing retraining)	4 weeks OR 1 week (If none of the traffic offences leading to the 1st suspension was involved in a traffic accident)
2nd suspension	12 points or more within 12 months	24 weeks	12 weeks (after passing retraining)	12 weeks
3rd suspension	12 points or more within 12 months	12 months	0	12 months (Licence revoked)
4th suspension	12 points or more within 12 months	24 months	0	24 months (Licence revoked)
5th suspension and above	12 points or more within 12 months	36 months	0	36 months (Licence revoked)

#### Multiple Notice Of Demerit Points Accumulated

- 24 Motorists will be notified and updated of their demerit point status after settling every offence where demerit points are awarded. The intent of the letter is to pre-warn the licence holders to improve their driving behaviour, and encourage them to remain offence-free for 12 months for their demerit points to be expunged; otherwise they may face the consequence of becoming liable for suspension.

#### Incentives For Good Driving Behaviour

- 25 A licence holder who maintains a 12-month period free of scheduled offences from the date of the last scheduled offence committed will have all his/her previous demerit points removed from his/her record.
- 26 A licence holder who maintains a 24-month period free of scheduled offences from the date of expiry of the last suspension will also have all his/her previous suspension(s) removed from his/her record, i.e. he/she will be treated similar to a driver with no previous suspension record.
- 27 Motorists with a clean driving record for a continuous period of three years will enjoy a discount over and above the usual No-Claim Bonus when they renew their insurance policy with participating insurance companies. They must also not have made any claims on their vehicles' insurance for the past three years.
- 28 The public can check on a driver's driving licence status and demerit points accumulated via Singapore Police Force e-Services at [www.police.gov.sg/e-services](http://www.police.gov.sg/e-services).

#### List Of Scheduled Offences Under DIPS

- 29 Under the DIPS, demerit points are given for the following list of scheduled offences under the Road Traffic (DIPS) Rules.

S/No.	Offences Committed	Demerit Points
1	Carrying excess pillion or carrying pillion sitting not astride	3
2	Rider failing to wear, or wearing insecurely, on his/her head a protective helmet	3
3	Disobeying the traffic direction of police officer, employee of Authority or security officer engaged in regulating traffic	3
4	Conveying a load not properly secured	3
5	Using tyres with ply or cord carcass exposed	3
6	Driver failing to wear seat belt	3
7	Parking abreast of another vehicle	3
8	Parking within a pedestrian crossing	3
9	Stopping in a zebra controlled (or more commonly known as zebra crossing) area	3
10	Driver failing to ensure that every passenger wears a seat belt	3
11	Using a motor vehicle where a person below 1.35 metres in height is a passenger and is not properly secured by an approved child restraint or a body-restraining seat belt	3
12	Parking within a Demerit Points No Parking Zone	3
13	Stopping within a Demerit Points No Stopping Zone	3
14	Failing to fill up every passenger seat in the driver's cabin, or any additional cabin or enclosed space provided for the carriage of passengers or goods and which is adjacent to or is an extension of the cabin for the driver, before carrying any person on the floor of an open deck goods vehicle	3

**Fine : Light Vehicle: \$150 ; Heavy Vehicle : \$200**

## PART A

### DRIVING LICENCES

S/No.	Offences Committed	Demerit Points
15	Exceeding the speed limit of a vehicle by 1 to 20 kilometres per hour	4
16	Exceeding the speed limit of a road by 1 to 20 kilometres per hour	4
17	Failing to give way to oncoming traffic at a controlled junction	4
18	Failing to give way at an uncontrolled junction	4
19	Failing to give way at a junction	4
20	Failing to give way at a roundabout	4
21	Crossing double white lines	4
22	Crossing a road divider	4
23	Obstructing the flow of traffic	4
24	Forming up incorrectly when turning left or right	4
25	Failing to give way to an ambulance, fire brigade or police vehicle	4
26	Driving while carrying a load on a motor vehicle in a dangerous manner	4
27	Stopping on the shoulder or verge of an expressway	4
28	Stopping or remaining at rest on the carriage way of an expressway	4
<b>Fine : Light Vehicle: \$150 ; Heavy Vehicle : \$200</b>		
29	Exceeding the speed limit of a vehicle by 21 to 30 kilometre per hour	6
30	Exceeding the speed limit of a road by 21 to 30 kilometres per hour	6
31	Driving on the shoulder of an expressway	6
32	Failing to securely tie or attach goods to a goods vehicle to prevent them from falling off the vehicle	6
33	Offences committed by motorists at a pedestrian crossing	6
34	Driving or riding against the flow of traffic as indicated by traffic signs	6
35	Careless driving	6
36	Carrying passengers on a motor vehicle or trailer in a dangerous manner	6
37	Reversing unnecessarily along an expressway	6
38	Failing to obey the 1.1 metre height restriction for persons carried on an open deck goods vehicle	6
39	Carrying passengers when the clear floor space of the open deck of a goods vehicle available for each passenger is insufficient	6
<b>Fine : Light Vehicle: \$200 ; Heavy Vehicle : \$250</b>		
40	Exceeding the speed limit of a vehicle by 31 to 40 kilometres per hour	8
41	Exceeding the speed limit of a road by 31 to 40 kilometres per hour	8
<b>Fine : Light Vehicle: \$300 ; Heavy Vehicle : \$400</b>		
42	Driving without due care or reasonable consideration for other road users	9
43	Carrying passengers on a goods vehicle in a dangerous manner	9
<b>Fine : Light Vehicle: \$300 ; Heavy Vehicle : \$400</b>		
44	Exceeding the speed limit of a vehicle by 41 to 50 kilometres per hour	12
45	Exceeding the speed limit of a road by 41 to 50 kilometres per hour	12
<b>Offender will be prosecuted in court</b>		
46	Failing to conform to traffic light signals	12
<b>Fine : Light Vehicle: \$400 ; Heavy Vehicle : \$500</b>		
47	Use of mobile telephone while driving	12
<b>1st offence: Fine not exceeding \$1000 or jail up to 6 months or both</b>		
<b>2nd and subsequent offence: Fine not exceeding \$2000 or jail up to 12 months or both</b>		
48	Exceeding the speed limit of a vehicle by 51 to 60 kilometres per hour	18
49	Exceeding the speed limit of a road by 51 to 60 kilometres per hour	18
<b>Offender will be prosecuted in court</b>		
50	Exceeding the speed limit of a vehicle by more than 60 kilometres per hour	24
51	Exceeding the speed limit of a road by more than 60 kilometres per hour	24
52	Reckless or dangerous driving	24
<b>Offender will be prosecuted in court</b>		

### MEDICAL EXAMINATION

30 Upon reaching the stipulated age limits, all licence holders are required by law to undergo a medical examination to certify their fitness to drive in order to validate their driving licence to continue to drive:

(a) **Class 2B, 2A, 2, 3, 3A, 3C and 3CA Driving Licence**

A Class 2B, 2A, 2, 3, 3A, 3C and 3CA licence (whichever applicable) shall cease to be valid upon the holder reaching the age of 65 years, unless the holder is certified physically and mentally fit to drive by a **Singapore registered medical practitioner** every 3 years from age of 65 (i.e. 65, 68, 71, 74 etc).

(b) **Class 4A, 4 and 5 Driving Licence**

A Class 4A, 4 and 5 driving licence shall cease to be valid upon the holder reaching the age of 65 years, unless:

- (i) the holder is certified physically and mentally fit to drive by a **Singapore registered medical practitioner** every year from age of 65 till age of 74; and
- (ii) the holder has passed a Proficiency Driving Test at the driving test centre.



## **PART A**

### **DRIVING LICENCES**

---

#### **ONLINE PORTALS**

- 31** For more information on driving in Singapore and general road safety, you are encouraged to refer to the following relevant websites:
- (a) **Singapore Police Force**  
<https://www.police.gov.sg/Advisories/Traffic/Traffic-Matters>
  - (b) **Singapore Road Safety Council**  
<https://srsc.org.sg>
  - (c) **Electronics Driver Data Information & Enquiry System (EDDIES)**  
<https://www.police.gov.sg/e-services>
  - (d) **One.Motoring**  
<https://onemotoring.lta.gov.sg>
- 32** For information on driving in overseas and application of International Driving Permit (IDP), you may refer to the following website:
- (a) **Automobile Association of Singapore (AAS)**  
<https://www.aas.com.sg>

**PART B**  
**SIGNS & SIGNALS**  
(To be tested during Basic Theory Test)

**SIGNS & SIGNALS**

- 33 Traffic signs are erected for 2 main purposes:
- (a) To regulate traffic movements.
  - (b) To warn and inform road users of hazards or give useful information.

**MANDATORY SIGNS**

- 34 These are compulsory signs. It is an offence to disobey them.



Turn right only



Turn left only



Ahead only



Turn right ahead



Turn left ahead



Keep left



Split traffic  
(Vehicles may pass on either side)



**Stop**  
(Stop before the white line.  
Give way to traffic from the right and left)



**Stop for children to cross the road**



**Give Way**  
(Slow down. Stop if necessary.  
Give way to traffic on major road)



**Left Turn on Red**

- Stop at the red light
- Give way to pedestrians crossing at the junction
- Give way to traffic approaching from the right
- Proceed only when the way is clear and it is safe to do so

**PROHIBITORY SIGNS**

35 Failure to comply with these signs constitutes an offence.



**No entry for  
all vehicles**



**No stopping**



**No waiting**  
(Vehicles may stop  
to allow boarding or  
alighting only)



**No Loading/Unloading**  
Weekdays 12.30 pm - 2.00 pm  
4.00 pm - 6.00 pm  
Saturday 12.00 noon - 2.00 pm

**No waiting and  
No loading/unloading  
during stated hours**



**No right turn**



**No left turn**





**Width limit**

(This sign prohibits the entry of vehicles with width in excess of 2.3m. The numerals on the sign may be altered to indicate different width restriction)



**Height limit** (This sign prohibits the entry of vehicles with an overall height in excess of 4.5m. The numerals on the sign may be altered to indicate different height restriction. Anyone who drives a vehicle with overall height exceeding 4.5m without police escort is committing an offence)



**Weight limit** (This sign prohibits the entry of vehicles with weight laden or unladen in excess of 10 tonnes. The numerals on the sign may be altered to indicate different weight restriction. Anyone who drives a vehicle with laden or unladen weight exceeding 10 tonnes without police escort is committing an offence)



**Speed limit**  
(Do not exceed 40 km/h)



**Speed limit**  
(Do not exceed 50 km/h)



**Speed limit**  
(Do not exceed 60 km/h)



**Speed limit**  
(Do not exceed 70 km/h)



**Speed limit**  
(Do not exceed 80 km/h)



**Speed limit**  
(Do not exceed 90 km/h)



**No sounding of horn**  
(Except to prevent accident)



**No overtaking**



**No entry for lorries**



**No entry for vehicles with 3 or more axles**



**No entry for motorcycles**



**No entry for motorcycles and pedal cycles**

**WARNING SIGNS**

36 Take extra care, slow down as you approach these signs.



**Right bend**  
(Slow down. Keep left. Do not overtake, make a U-turn or park your vehicle)



**Left bend**  
(Slow down. Keep left. Do not overtake, make a U-turn or park your vehicle)



**Series of bends**  
(Slow down. Keep left. Do not overtake, make a U-turn or park your vehicle)



**Cross junction**  
(Slow down. Beware of traffic approaching junction)



**T junction**  
(Slow down. Give way to traffic from the right and left)



**Side road**  
(Slow down. Beware of vehicles from the right)



**Side road**  
(Slow down. Beware of vehicles from the left)



**'Y' junction**  
(Slow down. Beware of traffic joining from the right and left)



**'Y' junction**  
(Slow down. Beware of traffic joining from the right)



**'Y' junction**  
(Slow down. Beware of traffic joining from the left)



**Merging traffic**  
(Slow down. Beware of traffic joining from the left)



**Staggered junction**  
(Slow down. Beware of vehicles from the right and left)



**Two-way traffic ahead**  
(Slow down. Keep left. Beware of oncoming traffic)



**Two-way traffic across a one-way carriageway**  
(Slow down. Beware of traffic from the right and left)



**Lanes merging**  
(Slow down. Beware of traffic merging from right or left)





**Road narrows on one side**  
(Slow down. Do not overtake, make a U-turn or park your vehicle)



**Road narrows on both sides**  
(Slow down. Do not overtake, make a U-turn or park your vehicle)



**Dual-carriageway ends**  
(Slow down. Keep left. Beware of oncoming traffic)



**Roundabout**  
(Slow down. Stop if necessary. Give way to traffic on the right)



**Light signals ahead**  
(Slow down. Beware of traffic lights changing)



**Pedestrian crossing ahead**  
(Slow down. Stop for pedestrian to cross at designated crossing)



**Electronic Road Pricing Zone ahead**  
(Pay a road user charge when entering the zone during restricted hours)



**Expressway ahead**  
(Certain types of vehicles are prohibited from using the expressway)



**Vehicle breakdown sign**  
(To be placed at least 20 metres from the rear of the vehicle)



**Slippery road**  
(Slow down.  
Drive carefully)



**Gated level crossing**  
(Slow down.  
Beware of gate closing)



**Ungated level crossing**  
(Slow down. Beware of  
train approaching)



**Uneven road**  
(Slow down. Keep left.  
Do not overtake)



**Road hump ahead**  
(Slow down. Keep left.  
Do not overtake)



**Steep upward slope**  
(Keep left. Change to  
a lower gear. Do not  
overtake, make a U-turn  
or park your vehicle)



**Steep downward slope**  
(Keep left. Change to  
a lower gear. Do not  
overtake, make a U-turn  
or park your vehicle)



**Road leading to quay,  
river bank or sea**  
(Slow down. Beware of  
road ending ahead)



**Animals**  
(Slow down.  
Beware of animals)



**Low flying aircraft ahead**  
(Beware of sudden noise  
from low flying aircraft)



**Raised zebra crossing ahead**  
(Slow down. Stop for  
pedestrians to cross  
at the raised zebra  
crossing)



**Elderly or handicapped pedestrians**  
(Slow down. Beware of elderly or  
handicapped pedestrians crossing the  
road)



**Children**  
(Slow down. Beware of children  
crossing the road)



**School Zone**  
Drive Carefully  
**Start of school zone**  
(Slow down and look  
out for children walking  
or crossing the road)



**U-turn ahead**  
(U-turn ahead  
for vehicles)



**U-turn ahead  
(From opposite direction)**  
(Beware of U-turning vehicles  
from opposite direction)



**School zone, 40km/h when lights flash**  
(Do not exceed 40km/h when the  
amber lights flash alternately)



**Pedestrian in road ahead**  
(Slow down.  
Beware of pedestrians  
Crossing the road ahead)



**Start of silver zone**  
(Slow down and look out for elderly  
pedestrians crossing the road ahead.  
Vehicles shall not travel above the posted  
speed limit as indicated in the speed limit  
sign attached)

**REGULATORY SIGNS**

37 These signs regulate the movements of traffic.



Slow down



Drive within the speed limit



Keep to the left side of the road and leave the outermost right lane for overtaking vehicles



Slow down and beware of obstruction ahead



Slow down and give way as traffic converges into single lane



Slow down and get ready to detour ahead





**Detour in the direction indicated**



**One-way traffic**  
(Vehicles may turn right or left)



**Sharp deviation**  
(Slow down and drive in the direction indicated)



**Barrier**  
(Slow down and drive carefully)



**One-way street**  
(One-way street begins from this sign)



**Curve Alignment Markers**  
(Slow down and drive carefully at bends)

**INFORMATION SIGNS**

38 These signs provide useful information to motorists.



**No through road**  
(Road on the right does not lead to another road)



**No through road**  
(Road ends in a short distance)



**'Terminus' with 'Terminal'**  
(For buses only)

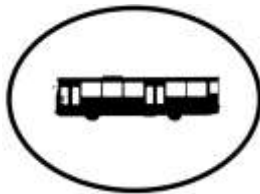

**Bus stop**  
(No parking or stopping within 9 metres of the bus stop or within the bus bay except omnibuses)



**For taxis only**



**For taxis only**



**Bus lane**  
(Vehicles other than buses are not allowed to use this lane during restricted hours)

**Normal Bus Lane Hours**  
(Denoted by a Continuous Yellow Line)



**Full-Day Bus Lane Hours**  
(Denoted by a Continuous Yellow-and-Red Line)



**Red light camera ahead**  
Get ready to stop when the signals change to "Amber"



**U-turn facility ahead**  
(Vehicles should U-turn after the sign)



**U-turn sign with vehicle weight restriction**  
(U-turn ahead for vehicles not exceeding the weight limit as stated on the sign)

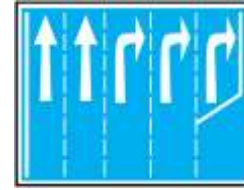

**Three turning lanes ahead**  
(Signal and filter to the correct lane)



**Bus Priority Box**  
(Also known as Mandatory Give-Way to Buses)  
(Slow down at the first Give-Way Triangle road marking and watch out for buses exiting bus stop. Stop before the Give-Way lines and give way to buses which are waiting to leave the bus stop. Do not stay in the yellow Give-Way Bus Box)



**Give-way to buses exiting.**  
(Slow down. Give way to buses exiting the bus bay)



**Four waiting lanes ahead**  
(Vehicles waiting to turn may take any of the four waiting lanes. Stop for pedestrians crossing the road)



**Exclusive left turn and shared left turn lane ahead**  
(Usually along expressway)  
(Signal and filter to the correct lane)



**Start of expressway**  
(Vehicles should comply with the Expressway Rules after this point)



**End of expressway**  
(Vehicles should slow down and drive within the speed limit of the road)



**Rain shelter for motorcyclists**



**Any vehicle parked in this zone may be towed away**



**Traffic signals operating hours**  
(Traffic signals not in operation during stated hours)

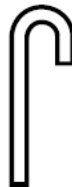

**White walking sticks**  
(Slow down. Stop if necessary to give way to blind people crossing the road)

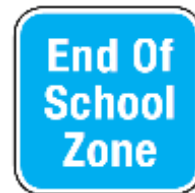

**End of school zone**



**End of silver zone**



**Any vehicle parked in this zone may have its wheel clamped**



**Speed regulating strips ahead**  
(Slow down)



**Parking Enforcement Camera**

**PEDESTRIAN CROSSING SIGNS**

39 Pedestrians should obey these signs when crossing the road.



Pedestrian overpass



Pedestrian underpass



Designated pedestrian crossing



Pedestrian signal  
**'Red Man'**  
(Do not cross)



Pedestrian signal **'Green Man'**  
(You may cross but do not cross when the light flickers)



**Countdown timer**  
(Indicates the remaining time (in seconds) for pedestrians to cross the road)



**Pedestrian crossing Prohibition**  
(Within these signs, pedestrians must use the designated crossing when crossing the road)

**TRAFFIC SIGNS FOR TUNNELS**

40 Traffic using the tunnel should heed and obey these signs.



**Tunnel Ahead**  
(The stretch of road ahead is in a tunnel)



**Vehicles carrying dangerous goods are not allowed in the tunnels**



**Switch on headlights and turn on radio (Local/BBC)**



**The GREEN Arrow** indicates that the lane is open for use



**The FLASHING AMBER Cross** is a caution signal to indicate possible obstruction ahead although the lane is open to vehicles. Drivers must slow down and be prepared to change lane



**The RED Cross** indicates that the lane is closed to traffic



**SIGNS FOR PEDAL-CYCLES**

41 Pedal cyclists should obey these signs.



No entry for bicycles



Bicycle stand



No entry for pedestrians and pedal-cycles



No parking of bicycles



This sign prohibits the riding of pedal-cycles (e.g. trishaws, tricycles and bicycles) beyond the point marked by the sign.



Cyclists Ahead



Bicycle Crossing

**Road Safety Tips for Cyclists**

Cycling groups on roads must not exceed the maximum length of 5 bicycles i.e. 5 cyclists in single file, or 10 cyclists when riding two abreast (where permitted to do so).

**Bicycles**

- (a) Must display a front white light and rear red light or reflector when cycling during hours of darkness.
- (b) A properly secured seat is required for pillion riders below 12 years old.
- (c) Always obey traffic light signals.
- (d) Cycle with the flow of traffic when on the roads.
- (e) Protective helmets must be worn when riding on roads.
- (f) Do not cycle on expressways, road tunnels and selected viaducts where bicycles are prohibited.
- (g) Bicycles are to be equipped with at least one functioning hand brake.
- (h) Do not use mobile communication devices when riding.
- (i) Cycle in single file on single-lane roads and during bus lane operational hours.
- (j) Wear bright-coloured clothing to increase your visibility to other vehicles.

**Power-Assisted**

- (a) You must only ride an LTA-approved power-assisted bicycle.
- (b) Minimum age for Power-Assisted Bicyclists, including pillion passengers, is 16 years old.
- (c) Protective helmets must be worn when riding Power-Assisted Bicycle.
- (d) Power-Assisted Bicycle must be registered and affixed with a rear number plate.
- (e) It is an offence to use the Mobile Communication Device while riding a Power-Assisted Bicycle or a Pedal Bicycle.

**Crime Advisory**

Secure your bicycle with a strong lock (e.g. U-lock) when left unattended, even if it is only for a short while.

Please refer to [www.lta.gov.sg/content/ltaweb/en/walk-cycle-ride/rules-and-code-of-conduct.html](http://www.lta.gov.sg/content/ltaweb/en/walk-cycle-ride/rules-and-code-of-conduct.html) for more information on the rules and code of conduct for cycling.

**DIRECTIONAL SIGNS**

42 Directional signs are usually rectangular with a green background. There are two types: Advance and Confirmation Directional Signs. Confirmation Directional Signs have a chevron shape on one end to indicate the direction.



Advance Directional Sign



Confirmation Directional Sign

43 On all roads leading to destinations along expressways, the signs have either:

(a) Yellow letters on green backgrounds with yellow borders, which will be phased out;



Advance Directional Sign



Confirmation Directional Sign

OR

(b) White lettering on green backgrounds, and the white text describing an expressway destination is encased in a blue background.



Advance Directional Sign



Confirmation Directional Sign



Intermediate Sign



Gantry Sign



Additional information on some directional signs have black letters on white backgrounds with black borders. The sign provides information on the road that you are approaching.

- 44 On all roads leading to destinations along roads other than expressways, the signs have white letters on green backgrounds with white borders.



Advance Directional Sign



Confirmation Directional Sign

**EXPRESSWAY MONITORING AND ADVISORY SYSTEM (EMAS)**

45 Motorists should look out for these three types of electronic signboards when travelling towards and along the expressways; and selected major arterial roads.

**(a) TRAVEL TIME DISPLAY (TTD)**

These electronic advisory signboards are placed at various entrances leading to the expressways. They provide estimated travel times to selected exits on the expressways from the point the motorist enters a particular expressway. For example, if a motorist enters CTE, he/she will notice the TTD as below. The estimated travel time to the expressway exit of Ang Mo Kio Avenue 1 is about 5 minutes from the point he/she enters CTE.

The estimated travel times are displayed in colour. Green indicates the travel time displayed is up to 50% more than normal travel time, yellow indicates the travel time displayed is between 50% to 125% more than normal travel time and red indicates the travel time displayed is more than 125% of normal travel time.

Messages are also displayed on this signboard pertaining to incidents on the expressway. For example, the message "ACCIDENT on CTE (SLE)" displayed on the TTD below informs motorists that there is an accident occurring on the CTE in the direction towards SLE.



Estimated travel times of journeys to destinations

- a) To Ang Mo Kio 1 exit is normal (green colour);
- b) To SLE exit is 50% more than the normal travel time (yellow colour); and
- c) To Woodlands Ave 2 exit is 125% more than the normal travel time (red colour)

Displayed destinations / expressway exits

Expressway symbol to denote travel journey via expressway

In the TTD below, the travel times are displayed in a single colour. The text "ACCIDENT" toggles with "ON CTE (AYE)" to inform motorists that there is accident occurrence on CTE in the direction of AYE. TTDs like these will be phased out.



**(b) TRAFFIC INFORMATION DISPLAY (TID) ON EXPRESSWAYS / SELECTED MAJOR ARTERIAL ROADS**

These large displays found along the expressways and selected major arterial roads display traffic information in text and simple graphic display up to seven colours. They inform motorists of traffic conditions ahead. A red cross indicates location with reference to the expressway exits or major road names labelled. A flashing red bar indicates road closure ahead. TIDs may also display information on incident type, lane(s) affected, congestion information, travel time information or other traffic advisory messages.

For example, if there is an accident on ECP in the direction towards Airport between Bayshore and Tampines exits, the TID below will alert motorists in advance for them to react accordingly.

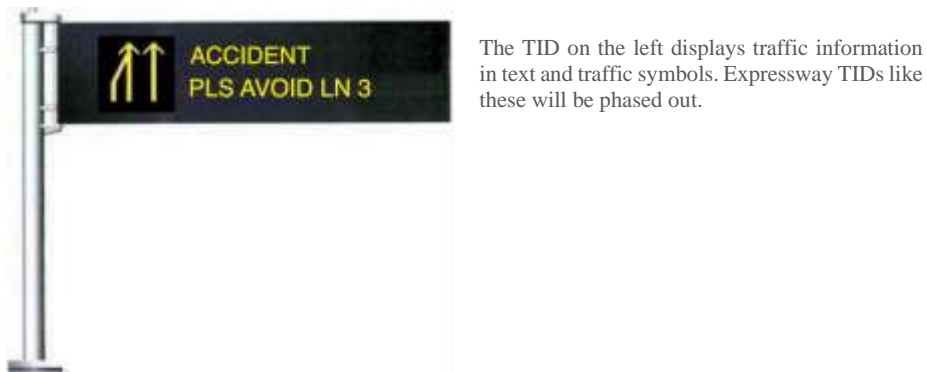
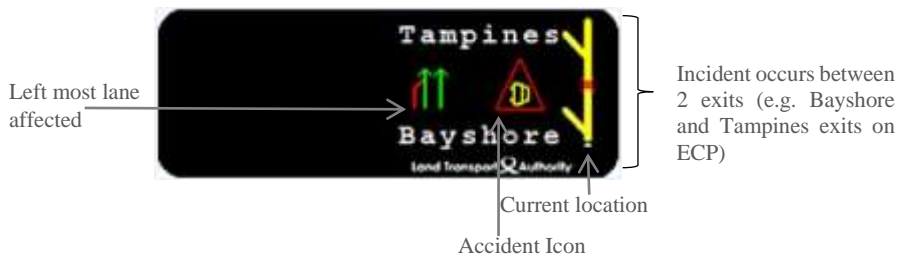

The following are examples of some other incident scenarios and graphical representations on EMAS TIDs.

(i) Road closure along expressway



(ii) Road closure at expressway exit



(iii) An incident occurs on a flyover or underpass along arterial roads

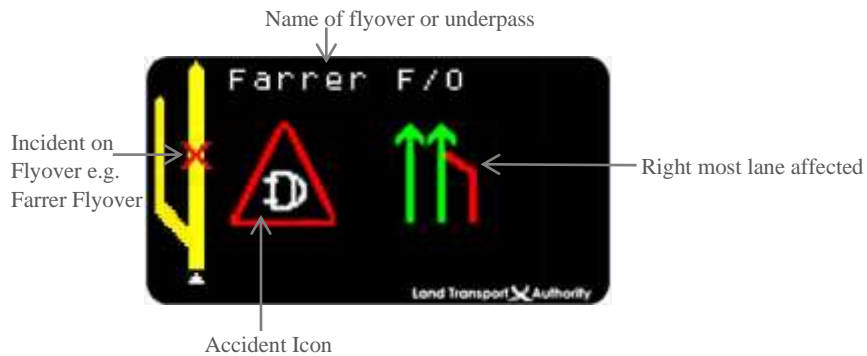

(iv) An incident occurs on the road next to a flyover or underpass along arterial roads



**(c) TRAFFIC SIGN DISPLAY (TSD)**

These are smaller signs generally found on the centre divider of expressways. Traffic symbols are displayed to indicate adverse traffic conditions or to provide instructions to motorists to change lanes.





**EMAS SIGNS**

46 Motorist should also be familiar with most of the traffic symbols used on the EMAS signboards. Some of the more commonly displayed ones are listed below. In addition, lanes are numbered in ascending order from the fast lane to the slow lane, excluding the road shoulder.



**Caution**  
(Slow down. Drive carefully. Beware of road conditions such as road sweeping, tree pruning, plant watering, spillage, debris or no lane marking on the road)



**Congestion**  
(Slow down. Drive carefully)



**Accident**  
(Slow down. Drive carefully. Beware of stopped vehicles and motorists)



**Vehicle Breakdown**  
(Slow down. Drive carefully. Beware of breakdown vehicles and motorists)



**Roadworks**  
(Slow down. Drive carefully. Beware of roadwork activities)



**Recommended Speed**  
(Drive at recommended speed)



**Must Exit**  
(Expressway closed ahead. Exit from expressway)



**Exit Closed Ahead**  
(Expressway exit closed ahead. Use alternative exits)



**Lane Reduction**  
(Obstruction at lane 3. Slow down. Drive carefully. Get ready to change lane if necessary)



**Lane Reduction**  
(Obstruction at lane 4. Slow down. Drive carefully. Get ready to change lane if necessary)



**Ambulance**  
(Look out and give way to ambulance)



**Fire Engine**  
(Look out and give way to fire engine)

Acronyms	Meanings
AFT	After
BEF	Before
LN	Lane
SH	Shoulder
VEH	Vehicle

Common EMAS Acronyms



**Event**  
(Drive with Care. Beware of event on road. Expect delays)



**Running Event**  
(Drive with care. Beware of running event on road. Expect delays)



**Cycling Event**  
(Drive with care. Beware of cycling event on road. Expect delays)



**Right & Left Turns Only**  
(Arterial Road – Through lanes closed ahead)



**No Left Turn**  
(Arterial Road – Left turn lane(s) closed ahead)

**FACILITY SIGNS**

47 Facility signs give motorists information of facilities and the direction to take to get to them. These signs have black letters on white backgrounds with black borders.



48 Directions leading to places of interest for tourists have white multi-lingual text on a brown background with white borders, white arrows and pictures.



**VEHICLE MARKINGS**

49 Vehicles carrying dangerous goods are required to display hazard information signs, e.g. DANGER- HIGHLY FLAMMABLE.



50 Long vehicles are required to display at least 3 yellow reflective markings on each side of the vehicle and at least 1 red reflective marking at the rear of the vehicle. This is to make them more conspicuous to other road users, especially at night.

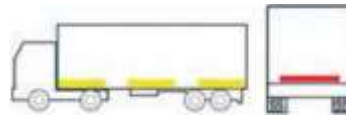

Long vehicles comprise:

- (a) Goods vehicles with length exceeding 10 metres;
- (b) Trailers with length exceeding 5 metres; and
- (c) Mobile cranes with length exceeding 10 metres



(Note: Mobile cranes require fitting of rear markings only).

51 Vehicle speed limit

Buses, goods vehicles and trailers are required to display a marking showing the maximum speed in kilometres per hour at which the vehicle may be driven or, in the case of a trailer, drawn on a road. Such vehicles must not travel faster than their vehicle speed limit or the posted road speed limit, whichever is lower.



**COMMON ROAD MARKINGS**

52 Common road markings **ACROSS** the road.



**(a) Parallel Broken White Lines**

Parallel broken white lines indicate that traffic approaching these lines must give way to traffic on a major road.



**(b) Single White Line**

Horizontal white line indicates that traffic is required to stop and must stop close to and before this line.



**(c) Parallel Dashed / Solid White Lines**

Parallel dashed or solid white lines (will be phased out) accompanied by pedestrian signals (Green Man/Red Man) indicate a designated crossing. Turning vehicles must give way to pedestrians when the 'Green Man' is lighted.

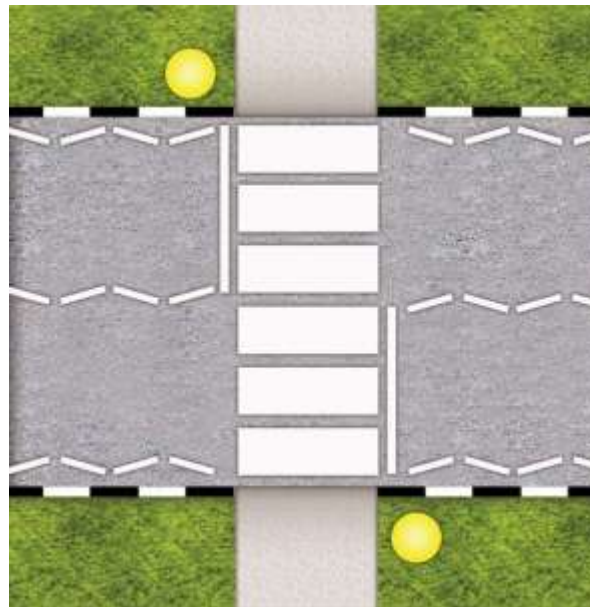

**(d) Zebra Crossing**

Slow down and stop if there are pedestrians or cyclists crossing or about to cross.



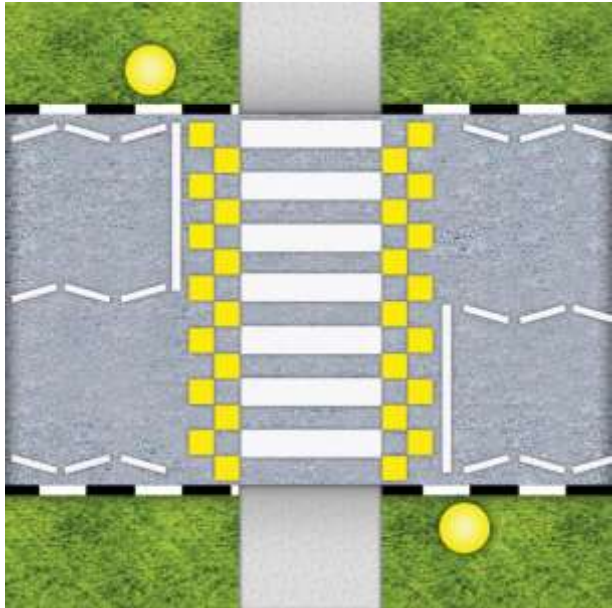

**(e) Raised Zebra Crossing**

Slow down and stop if there are pedestrians or cyclists crossing or about to cross. Beware of raised hump.

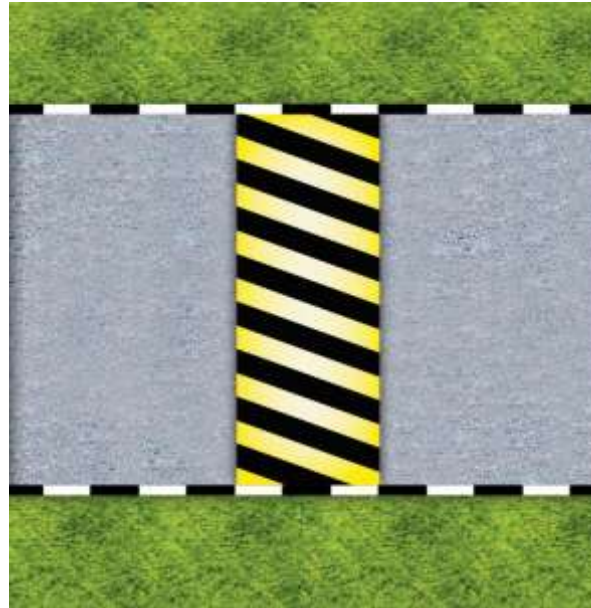

**(f) Hump**

Slow down.

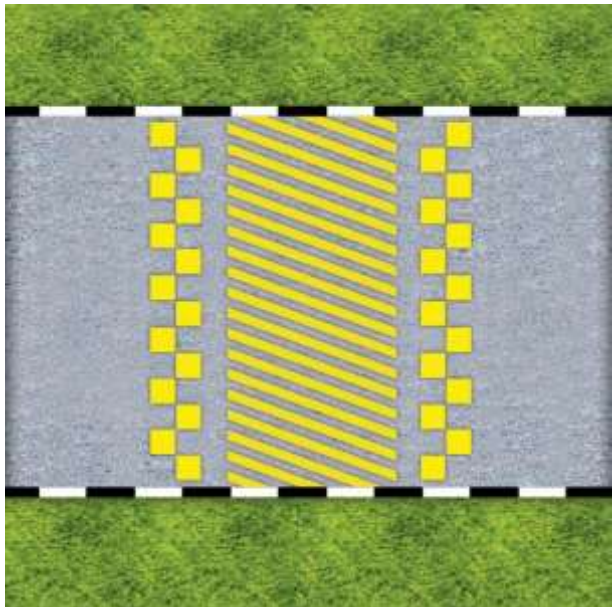

**(g) Bus-Friendly Hump**

Slow down.

53 Common road markings **ALONG** the road.

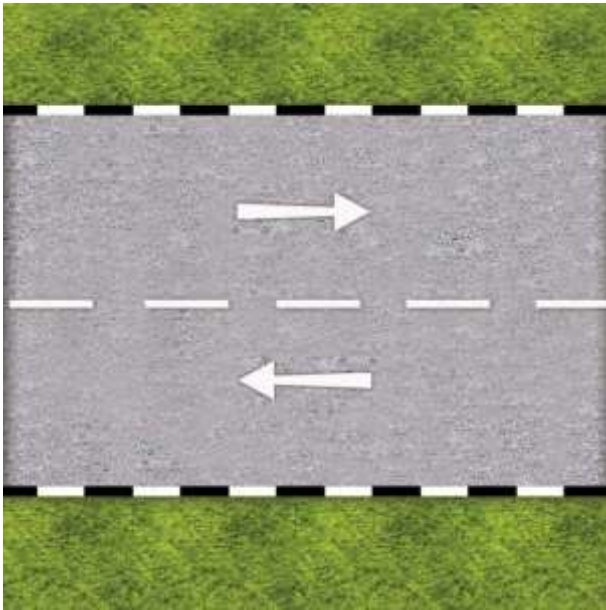

**(a) Broken White Line**

A broken white line is the centre line of a two-way road. Vehicles should keep to the left of this line.

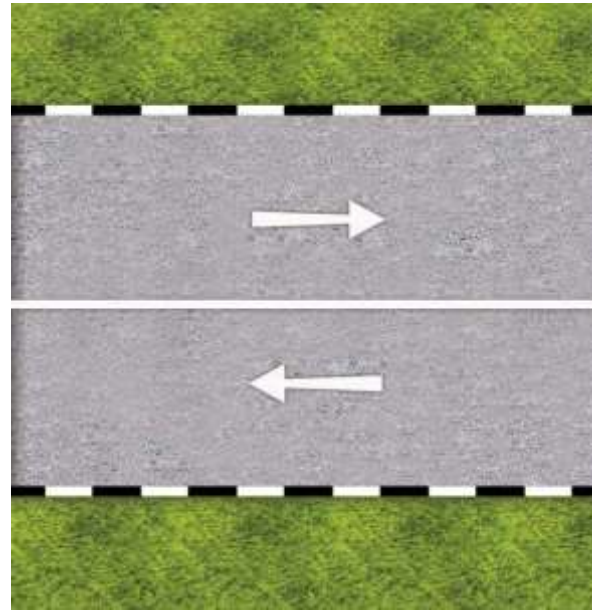

**(b) Continuous White Line**

A continuous white line is the centre line of a two-way road. Vehicles should keep to the left of this line. Parking is not allowed on either side of the road at all times.

Motorists can only cross a single continuous or broken white line when they can see that the road ahead is clear & it is safe to do so.

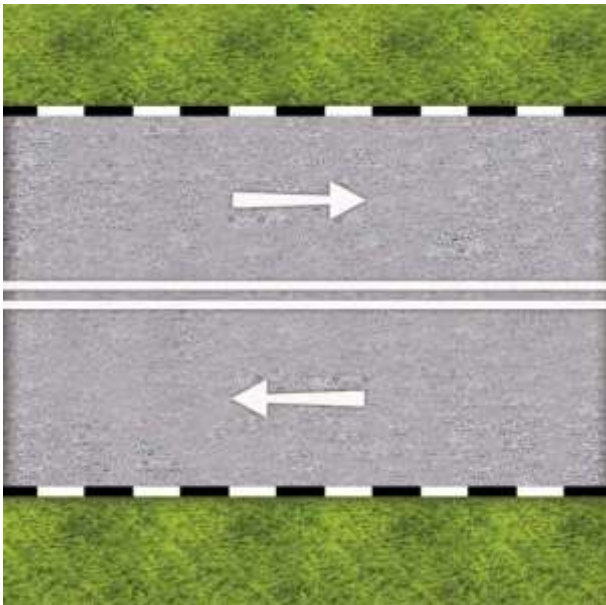

**(c) Unbroken Double White Lines**

Parallel continuous white lines in the centre of a two-way road indicate no parking on either side of the road at all times. Vehicles are also not allowed to cross these lines.

Where continuous double white lines are painted on a road to separate traffic flowing in opposite directions, you may not overtake at the double white lines unless you keep entirely to the left of such lines.

*Never cross double white lines.* Making a U-turn or a right turn is not allowed on a road where such lines are painted.



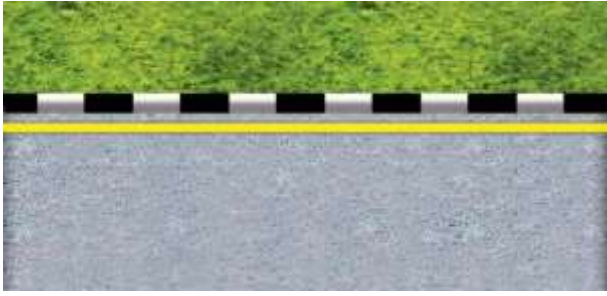

**(d) Unbroken Yellow Line**

An unbroken yellow line indicates no parking between 7.00am and 7.00pm on that side of the road where the line is drawn, except on Sundays and public holidays.

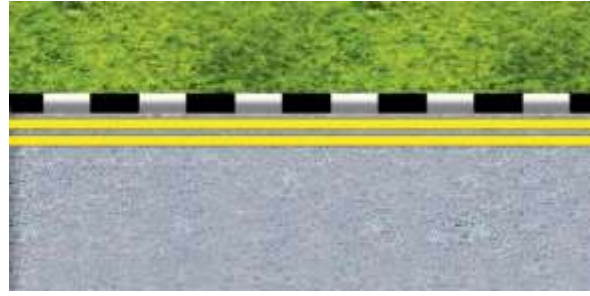

**(e) Unbroken Double Yellow Lines**

Unbroken double yellow lines indicate no parking at all times on that side of the road where these lines are drawn, except for the immediate picking up and letting down of passengers.

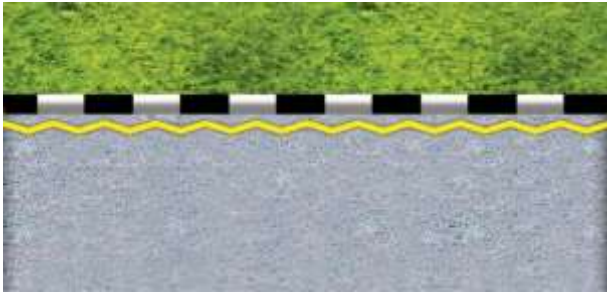

**(f) A Single Yellow Zig-Zag Line**

A single yellow zig-zag line indicates No Parking at all times on that side of the road where the line is drawn, except for the immediate picking up and letting down of passengers. Violation of this rule attracts demerit points and a fine.

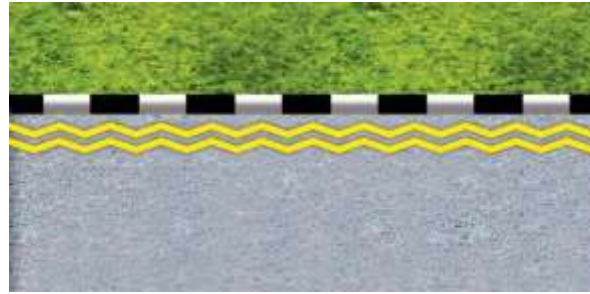

**(g) Double Yellow Zig-Zag Lines**

Double yellow zig-zag lines indicate No Stopping at all times on that side of the road where the lines are drawn. Violation of this rule attracts demerit points and a fine.



**(h) Broken White Line at Accelerating Lane**

A broken white line indicates the edge of a road adjacent to an accelerating lane.



**(i) Broken White Line at Decelerating Lane**

A broken white line indicates the edge of a road adjacent to a turning or decelerating lane.

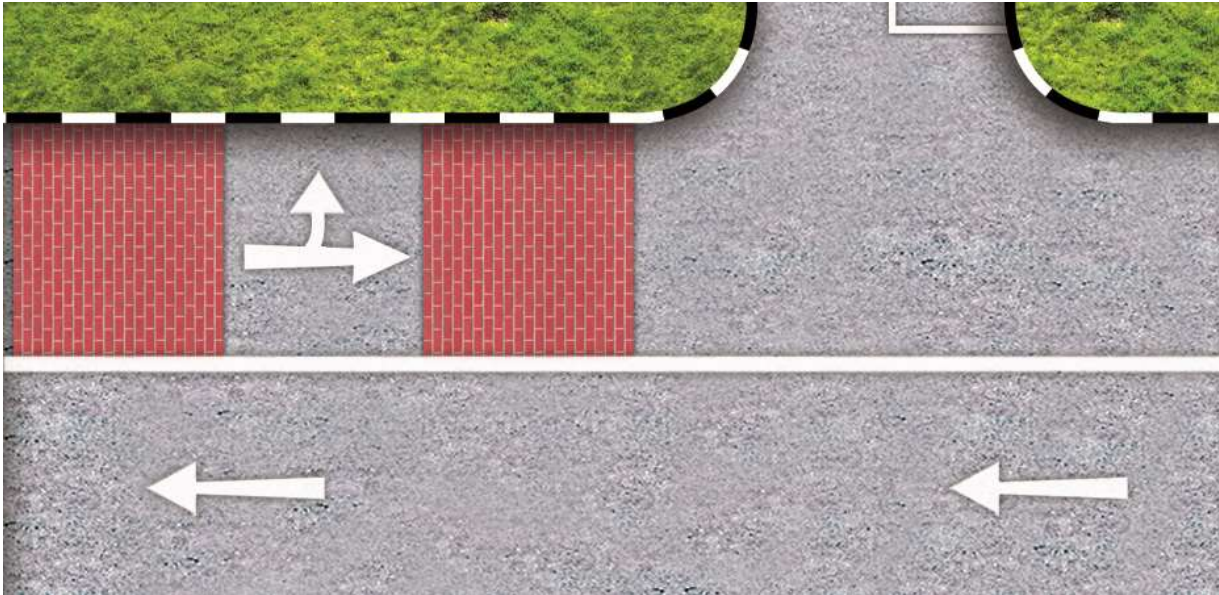

**(j) School Zone**

The sections in brick red indicate a **school zone**. Slow down and look out for children on the road.

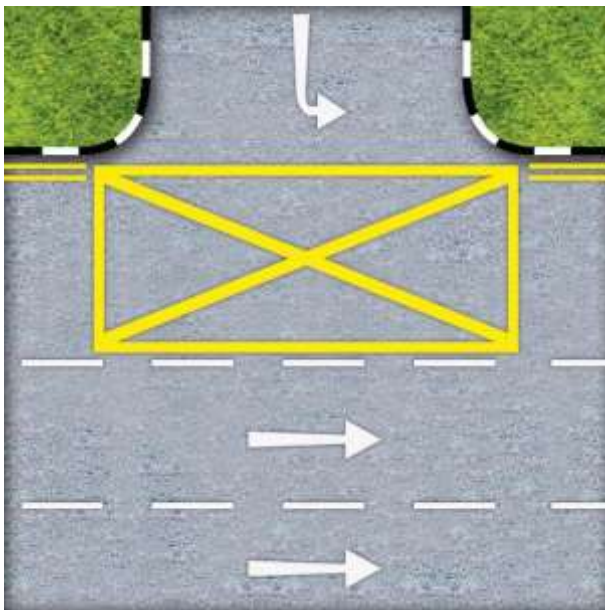

**(k) Yellow Box**

Do not drive into the yellow box when traffic has come to a standstill at the left lane. Give way to vehicles from the side road entering the main road.

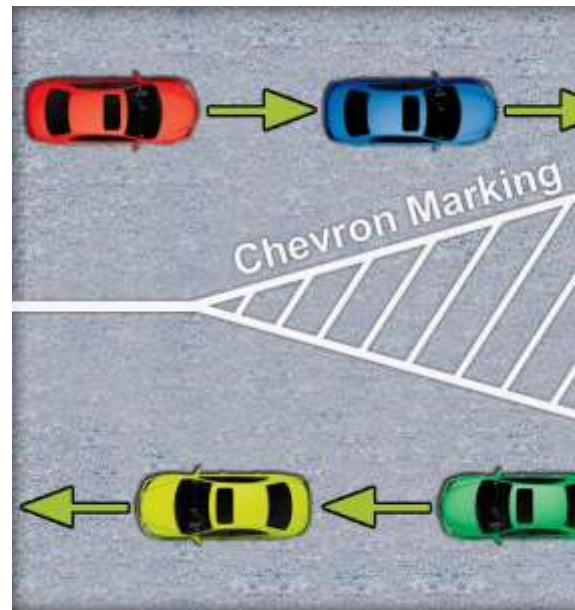

**(l) Chevron Areas**

Chevron markings are used to channel traffic. The white lines indicate the chevron area. No driving or parking of vehicles in the chevron area.



**Bus Lanes**

**54** Vehicles other than omnibuses, bicycles, emergency service and police vehicles must avoid using the bus lanes during restricted hours. Non-scheduled buses such as school and factory buses may use the bus lane. However, they are not allowed to stop, pick up or let their passengers alight along bus lanes.

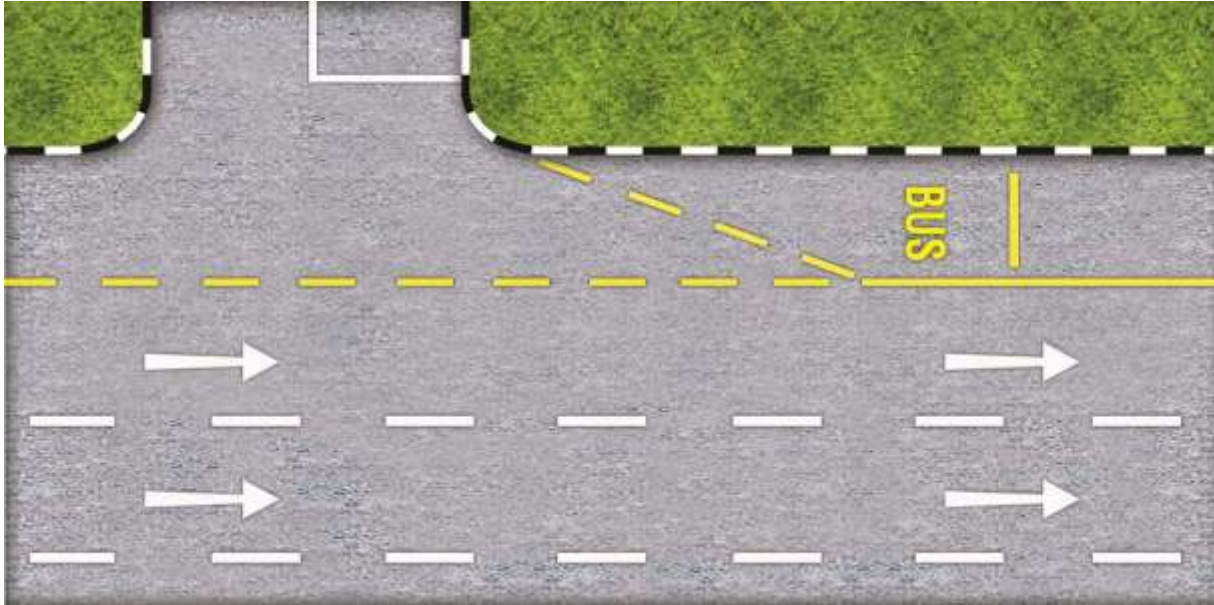

**(a) Normal Bus Lane**

A continuous yellow line and a short horizontal line at intervals indicate a normal bus lane. No driving or parking of vehicles in the bus lane during the bus lane operational hours - Mondays to Fridays: 7.30am to 9.30am and 5.00pm to 8.00pm, except on Saturdays, Sundays & Public Holidays. Vehicles can use the bus lane where there is a broken yellow line to turn into a side road or turn from a side road into the bus lane road.

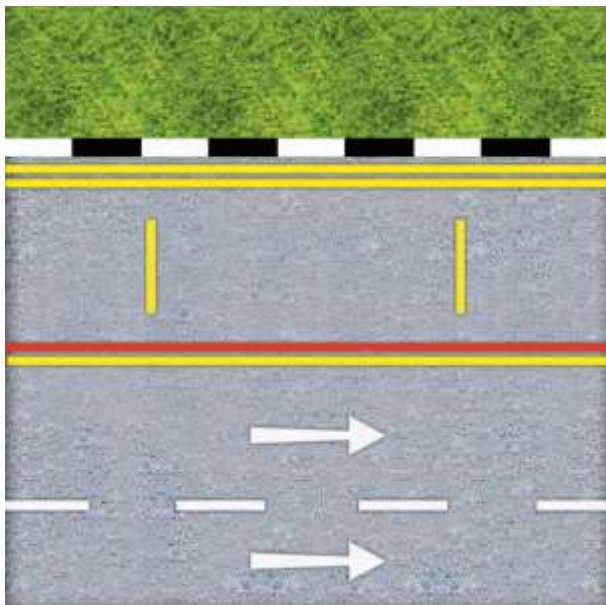

**(b) Full-Day Bus Lane**

An additional red line marked parallel to the yellow line indicates a full-day bus lane. No driving or parking of vehicles in bus lane during the full-day bus lane operational hours - Mondays to Saturdays: 7.30am to 11.00pm, except on Sundays & Public Holidays.

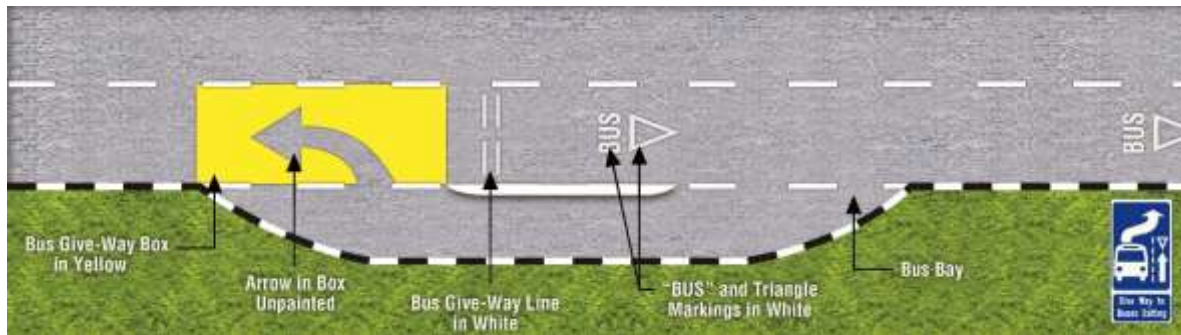

**(c) Bus Priority Box (also known as Mandatory Give-Way to Buses)**

The section in yellow indicates a mandatory give-way to buses area. Slow down and watch out for buses pulling out of the bus bay. Stop before the give way line and give way to buses exiting the bus bay at the location.



**(d) Enhanced Chevron Zone at Bus-Stop Separator**

Bus-stop separator areas are painted red to alert motorists of the presence of merging vehicles from bus-stops. No driving or parking of vehicles in the enhanced chevron zone.

55 Common road markings ON the road.

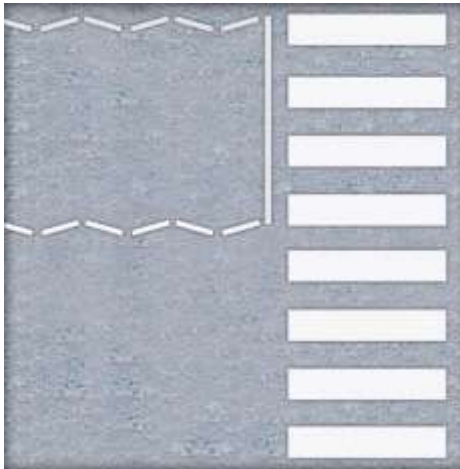

**(a) Zig-Zag Lines by Side of the Road**

Zig-zag lines by the side of the road give advance warning of the presence of a Pedestrian Crossing. The white zig-zag lines indicate no stopping at all times on this road. Vehicles should not overtake, or wait in the vicinity. Pedestrians are also prohibited from crossing at the zig-zag areas.

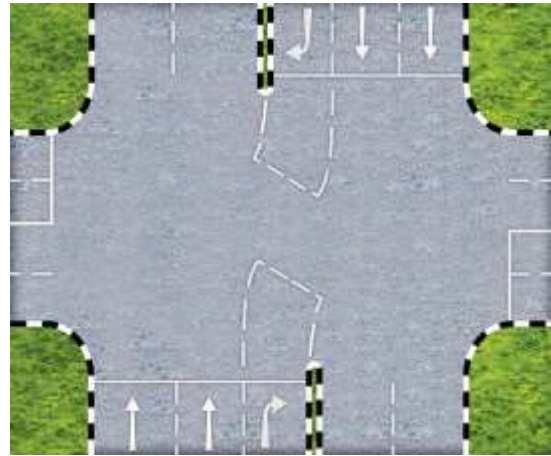

**(b) Right-Turn Pocket**

Vehicles turning right at road junctions should stay within the pocket until it is clear to complete the turn.

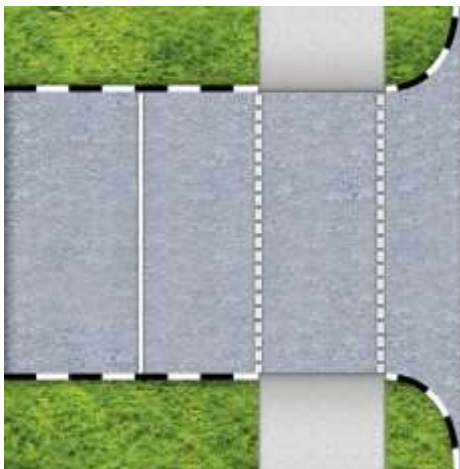

**(d) Dashed Pedestrian Crossing Lines**

These lines provide better contrast of the pedestrian crossing lines with the stop line to better demarcate the crossing area for pedestrians. Motorists should comply with the stop line for pedestrians to cross.

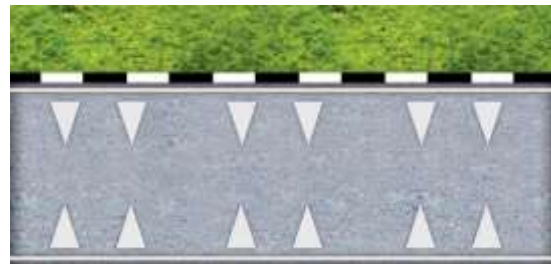

**(c) Traffic Calming Markings**

A series of triangular markings of the side of the road to create a visually narrowed road to encourage motorists to slow down.



**(e) Pedestrian Crossing Ahead Markings**

These markings warn motorists of Zebra Crossing ahead. Motorists should watch out and give way to pedestrians.



**PART B**  
**SIGNS & SIGNALS**

**DIRECTION ARROWS**

56 You should only proceed in the directions shown by the arrows.

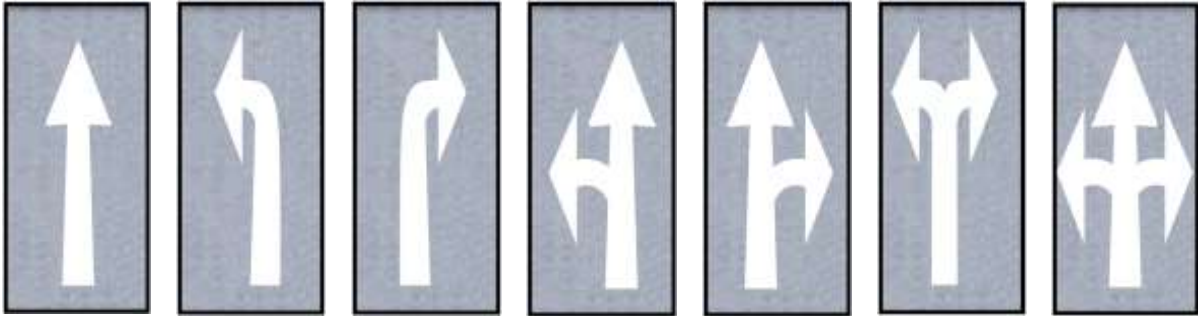

**MERGING ARROW MARKINGS**

57 Merging arrows are drawn on the road to give motorists advance warning that two traffic lanes are merging into one traffic lane. Alternate vehicles from the two lanes have the right-of-way into the single lane.

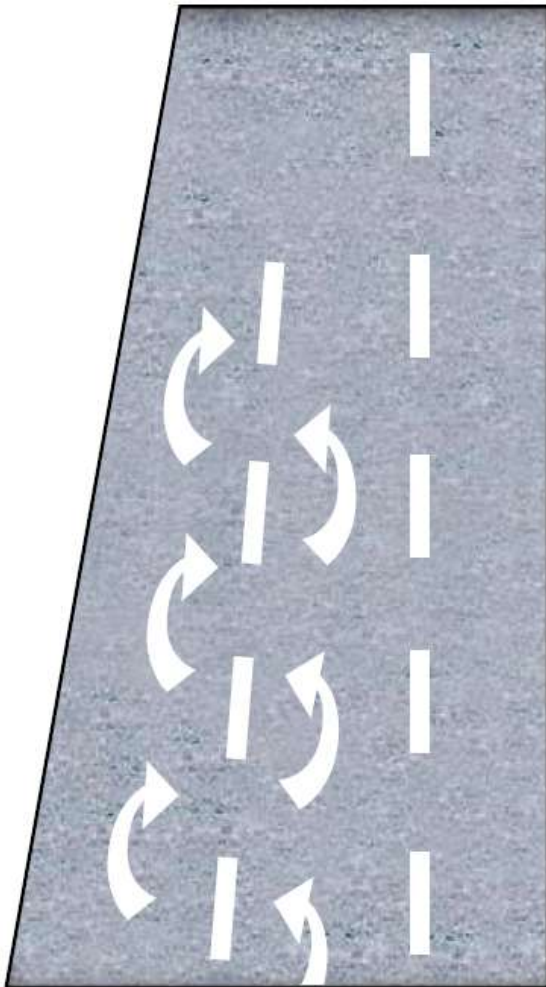



**SIGNALS (TRAFFIC LIGHTS)**

58 Traffic Lights



**RED**  
Means "STOP".

**ALL RED**  
Some junctions have an ALL RED period for safety or for pedestrians to cross. This means that all the approaches are simultaneously showing the red signals. Do not start to move until the green light appears in your favour.



**AMBER**  
Means "STOP" unless you are so close to the stop-line when the lights turn AMBER that you cannot stop safely.

**FLASHING AMBER**  
Means that the traffic light signals are out of order. Proceed with caution. Give way to traffic on the right.



**GREEN**  
Means "GO".  
Look to the right and left to ensure it is safe before you proceed.



**GREEN ARROW**  
Means "GO" but only in the direction indicated after ensuring that oncoming traffic is clear.  
**FLICKERING GREEN ARROW**  
Means signal is about to be cancelled. Do not proceed if you have not crossed the stop-line.



**GREEN 'B'**

Means "GO" for all buses only. This is to allow them to move out of a bus-bay or a side lane and proceed ahead of other vehicles.



**ADVANCED WARNING LIGHTS**

A signal with two "flashing amber" lights, "light signals ahead" sign and a blue "prepare to stop" sign. It is erected before bends where visibility of the traffic light ahead is unsatisfactory. Vehicles should slow down and be prepared to stop.



**GREEN ARROW**  
Means "GO" in the direction indicated.  
(Turn right)



**AMBER ARROW**  
Means "READY TO STOP" behind the stop-line in the direction indicated.



**RED ARROW**  
Means "STOP" behind the stop-line in the direction indicated. (Do not turn right even when there is no traffic from the opposite direction)

**PART B**  
**SIGNS & SIGNALS**

Signals (Traffic Lights) / Signals (On the Road)

**EXAMPLES**



Means “GO” for straight ahead vehicles and “GO” for right turn vehicles.



Means “GO” for straight ahead vehicles only. Vehicles turning right must get ready to “STOP”.



Means “GO” for straight ahead vehicles only. Vehicles turning right must stop behind the stop line.

**SIGNALS (ON THE ROAD)**

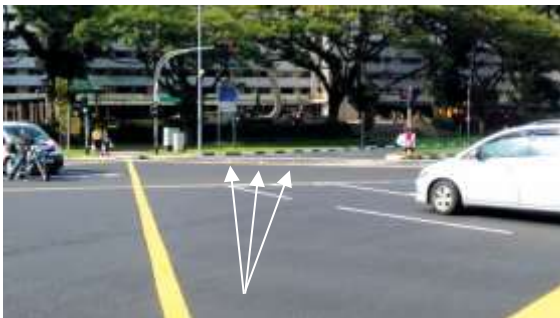

**Road Studs in the Day**

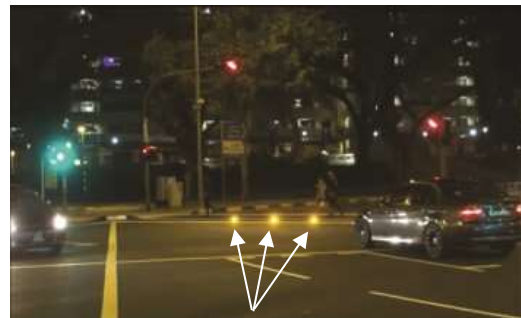

**Road Studs at Night**

**59 Intelligent Road Studs**

Blinking devices that are activated when the green man signal comes on. Turning vehicles should watch out and give way to pedestrians crossing the road.

**SIGNALS GIVEN BY A POLICE OFFICER**

**60** Signals given by Police Officers directing traffic take precedence over those conveyed by road signs, traffic light signals, road markings and traffic regulations.



- (a)  
Vehicles approaching Police Officer from all directions to stop.



- (b)  
(i) Vehicles approaching Police Officer from front and behind to stop.  
(ii) Vehicles approaching from his/her right and left may proceed.



- (c)  
(i) Vehicles approaching Police Officer from his/her right, front and behind to stop.  
(ii) Vehicles approaching from his/her left may proceed.



- (d)
- (i) Vehicles approaching Police Officer from front and behind to stop.
- (ii) Vehicles approaching from his/her right may proceed. Vehicles approaching from his/her left be ready to stop - signal is about to change.



- (e)
- (i) Vehicles approaching Police Officer from his/her left, front and behind to stop.
- (ii) Vehicles approaching from his/her right be ready to stop. Signal is about to change.



- (f)
- (i) Right-turning vehicles in front of Police Officer may proceed.
- (ii) Vehicles approaching from all other directions to stop.



**HAND SIGNALS**

61 Before you:

- (a) Turn or move towards the right/left;
  - (b) Stop or slow down;
  - (c) Pull out from a parking place; or
  - (d) Pull out to pass,
- give a clear signal and in good time to let other road users know your intention.

Motorcyclist

Cyclist



*I intend to move out to the right or turn right*



*I intend to move in to the left or turn left*



*I intend to slow down*



*I intend to stop*



## PART B

### TRAFFIC RULES & REGULATIONS

### The Keep-Left Rules / Lane Discipline / Overtaking

#### THE KEEP-LEFT RULE

- 62 When driving along two-way streets, keep well to the left and as near as practicable to the boundary of the road, except when you intend to overtake or turn right. Do not hog the middle of the road. This applies to dual-carriageways as well.
- 63 You must not cross the centre line at bends, near the crest of a rise or anywhere else where you cannot clearly see the road ahead.
- 64 Sometimes your path of travel may be obstructed by road works, parked vehicles etc. In such circumstances, to avoid the obstruction, take extra care to ensure that your intended path is safe and clear before you move to the right. You may cross the centre line if the roads are narrow.

#### LANE DISCIPLINE

- 65 You must obey the directions indicated by arrows marked in the lanes. See illustration below. You must not change lanes suddenly as you may inconvenience or endanger other motorists. When changing lanes, give sufficient warning of your intention. Always signal in advance. Failure to do so could cause an accident.
- 66 In traffic hold-ups, do not “jump the queue”. Trying to get ahead of others by squeezing between lanes and overtaking recklessly is courting disaster. Always be patient and have consideration for other road users.
- 67 Well before you reach a junction, make sure that you get into the correct lane for whichever direction you wish to take.
- 68 On a two-lane carriageway, keep to the lefthand lane except when overtaking.
- 69 On a three-lane carriageway, you may keep to the centre lane when the left-hand lane is occupied by slower moving vehicles. The outer (right-hand) lane is for overtaking and emergency vehicles only.



#### OVERTAKING

- 70 Never overtake unless you can do so without endangering yourself or others. Be especially careful at night, and in heavy rain and mist. When visibility is poor, it becomes more difficult to judge speed and distance.
- 71 Always overtake on the right. There are, however, a few exceptions to this rule when you can overtake on the left:
- When the driver in front has signalled his/her intention to turn right.
  - When you want to turn left at a junction.
  - When traffic is moving slowly in queues and vehicles in the lanes on your right are moving more slowly than you are.
  - On one-way streets (but not dual-carriageways) where vehicles may pass on either side.
- 72 After overtaking, return to the appropriate lane on the road as soon as it is safe to do so, but do not cut in sharply in front of the vehicle you have just overtaken.
- 73 Do not overtake when you are at, or when you are approaching:
- A pedestrian crossing.
  - A road junction.
  - A corner or bend.
  - The brow of a hill.
  - Double white lines.
- 74 Do not overtake:
- Where the road narrows.
  - If it would force another vehicle to swerve or reduce speed.
  - If in doubt.
- 75 Do not increase your speed while being overtaken. Slow down if necessary to let the overtaking vehicle pass.
- 76 In the following cases, overtaking is dangerous and should not be attempted:
- When the car in front of you is about to overtake the car in front of it.
  - When the car in front is changing from the left to the right lane in order to make a right turn.
  - When you have to get into the path of oncoming traffic in order to overtake.

77 Correct method of overtaking - The 12 steps illustrated below show you the correct method of overtaking another vehicle safely.

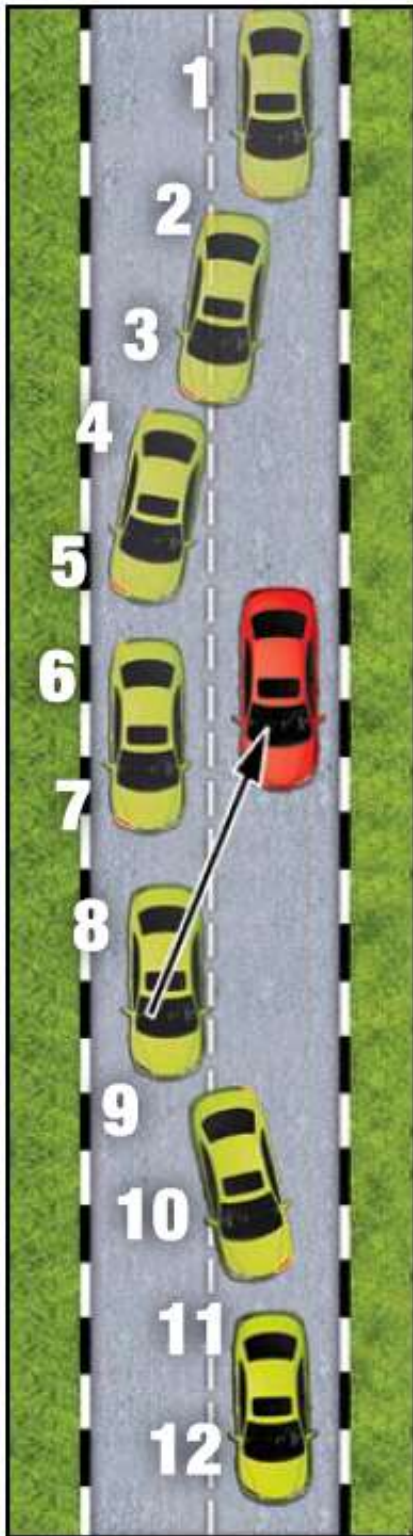

- 1 **CHECK TRAFFIC AHEAD**
- 2 **CHECK TRAFFIC BEHIND**
- 3 **SIGNAL RIGHT**
- 4 **CHECK BLIND SPOT**
- 5 **MOVE RIGHT**
- 6 **ACCELERATE**
- 7 **TAP HORN (if necessary)**
- 8 **CHECK MIRROR**
- 9 **SIGNAL LEFT**
- 10 **MOVE LEFT**
- 11 **CANCEL SIGNAL**
- 12 **RESUME NORMAL SPEED**

**ROAD-HOGGING**

**78** Road-Hogging is driving at an unreasonably slow speed on the road especially on the right-hand or along the centre of the road. Road-Hogging hinders the flow of traffic behind and may cause other vehicles to pass dangerously on the left. Motorists who travel at a slow speed should keep to the left side of the road; this applies especially to small capacity motorcycles, goods vehicles and lorries. You should only use the right hand lane when overtaking or when you are about to turn right or make a U-turn.

**SPEED LIMITS**

**79** Unless otherwise stated, the speed limit of all roads in Singapore is 50 km/h. Do not exceed the speed limit of your vehicle or the road, whichever is the lesser.

**80** Always obey the "Reduce Speed Now" sign.

**THE 'GIVE WAY' RULE AT ROAD JUNCTIONS**

**81** When approaching a junction with a major road, slow down gradually and give way to traffic on the major road. Where there is a "STOP" sign, stop before the stop-line.

**82** At an uncontrolled junction where there are no traffic lights, "GIVE WAY" sign or "STOP" sign:

(a) If you are going straight across the junction, you must give way to traffic going straight from the right.

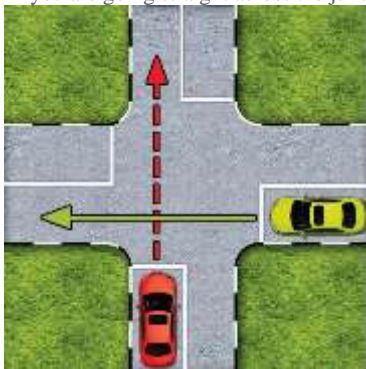

(b) If you are turning right, you must give way to traffic going straight from all directions, as well as traffic turning right from the right and traffic turning left from the opposite direction.

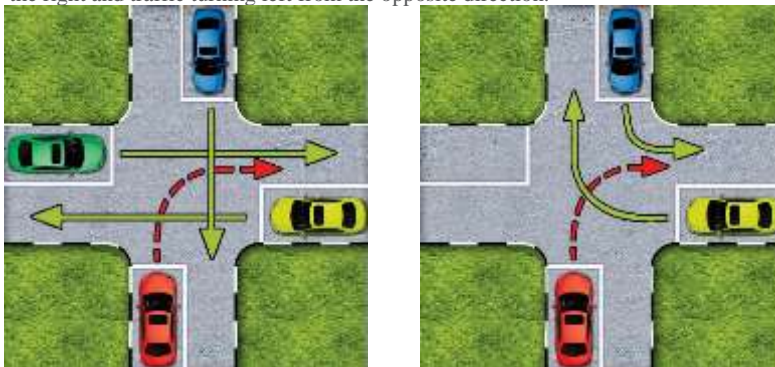

(c) If you are turning left, you must give way to traffic going straight from the right.





## PART B

### TRAFFIC RULES & REGULATIONS

### The "Give Way Rule" At Road Junctions / Roundabouts

- 83 At a junction, look right, then left, then right again. Do not proceed until you are sure that it is safe to do so. Do not rely on signals to go ahead given by unauthorised persons.
- 84 Well before you turn right at a junction, take full account of the position and movement of traffic behind you. When it is safe to do so, signal your intention and take up a position just left of the middle of a two-way street or to the extreme right lane of a one-way street. Wait there until there is a safe distance between you and any approaching vehicle before you complete your turn.
- 85 When turning right into a two-way street, turn into the lane just left of the centre line of the road you are turning into.
- 86 When turning right into a one-way street, turn into the extreme right lane of the road you are turning into.
- 87 If you intend to turn left, keep to the left, signal in good time, and do not swing out to the right before or after making the turn.
- 88 When a vehicle turns, the rear nearside wheel tends to pull closer to the kerb. So when making a turn, take special care not to brush against pedestrians, bicycles or motorcycles.

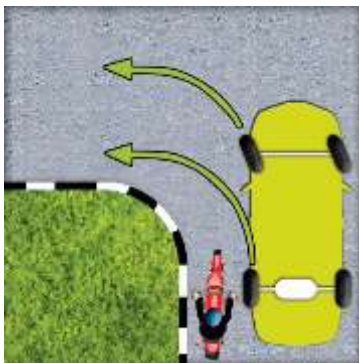

Notice the wide difference between the arcs that the front and rear nearside wheels take when making a turn.

## ROUNDBABOUTS

- 89 Slow down when approaching a roundabout and give way to traffic on your right.
- 90 The general rule is that:
- traffic from lane A as in the illustration goes to 'A'.
  - traffic from lane B goes to 'B'.
  - traffic from lane C goes to 'C'.

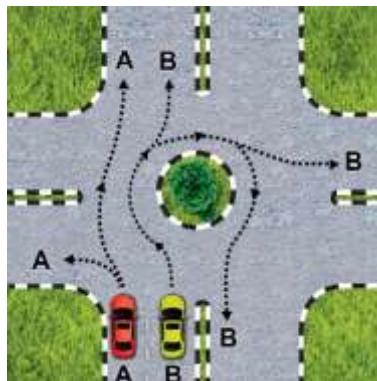
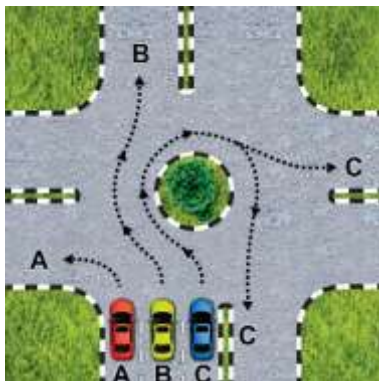

**REMEMBER** - Traffic coming from your right takes priority over you.

### Rules for Motorists

You must always give way to traffic approaching from your right. You are advised to exercise caution at all times, and decide as early as possible which exit you need to take. Take note of and act on all the information available to you from traffic signs, traffic lights and road markings that direct you into the correct lane. Always remember that you have to:-

- Give clear signals showing your intention in good time;
- Obey the right-hand rule;
- Not inconvenience other drivers;
- Use your mirror intelligently to see that you do not obstruct the path of vehicles behind you; and
- Show consideration to other road users in the interest of road safety.



## PART B

### TRAFFIC RULES & REGULATIONS

#### DRIVING ON EXPRESSWAYS

- 91 Do not drive, move or stop on road shoulder or verge unless in the event of a breakdown, accident or emergency.
- 92 Vehicles which have a speed limit of 60 km/h and below shall be driven along the left hand lane of the expressway.
- 93 Cycling, skating and walking are prohibited on expressways.

#### YELLOW-BOX JUNCTIONS

- 94 It is an offence for any driver to drive his/her vehicle into a junction marked with a yellow box and cause obstruction even if the lights are in his/her favour. However, there are certain situations in which a driver or rider will not be penalised for entering the yellow-box junction.

(a) **Situation One**

The first is when the turning vehicles in a box-junction do not block other vehicles. Only drivers of turning vehicles A, B and C and NOT those marked X may enter the yellow box when their exit lanes from it are blocked by other vehicles. Should the traffic lights change to red, vehicles A, B and C would not cause any obstruction to other vehicles. However, vehicles marked X would be obstructing traffic should the lights change and the drivers will be penalised, as such they should wait behind the stop-line at 'Y'.



**(b) Situation Two**

The second situation is when motorists are waiting in the yellow box while trying to turn right in the face of oncoming traffic. Drivers of vehicles marked A, B and C can remain in the box until a suitable opportunity arises for them to complete their turns. Should the lights turn red against them, they should proceed to complete their turn and clear the yellow box junction.

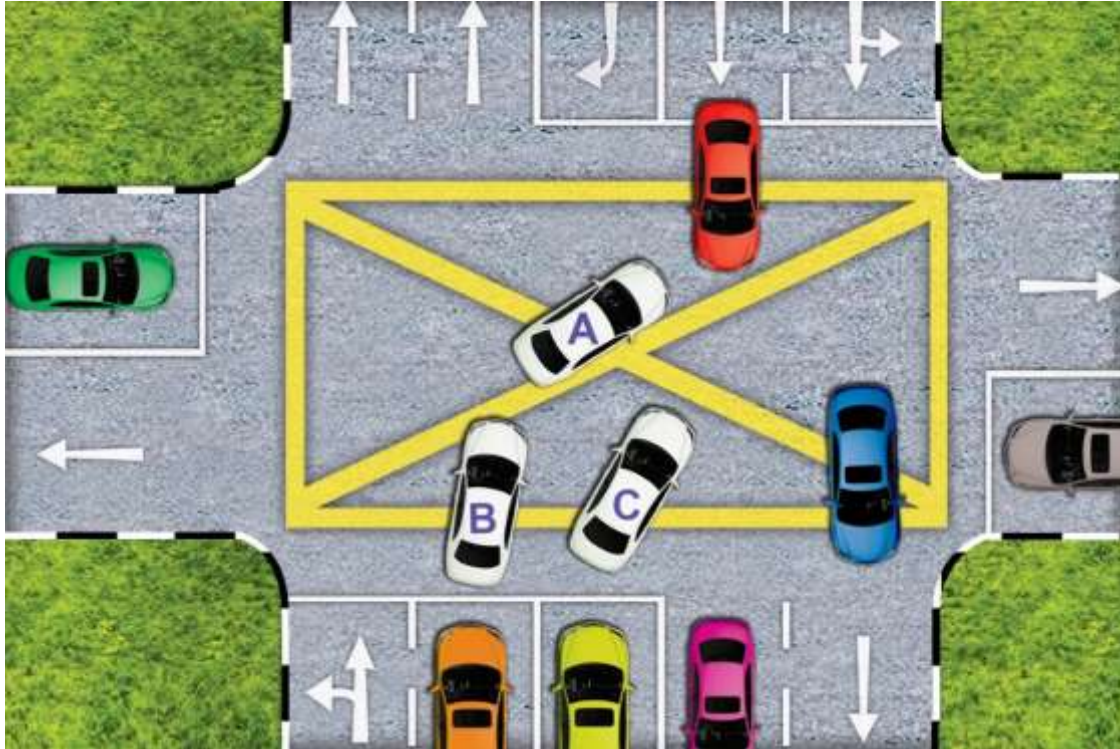

**(c) Situation Three**

The third situation is when motorists are waiting in a yellow box junction while making left or right turns because of pedestrians crossing the road. The diagram shows that the drivers of vehicles A, B, C, D and E may enter the yellow box even when they are prevented from executing their turns by pedestrians using the crossings.

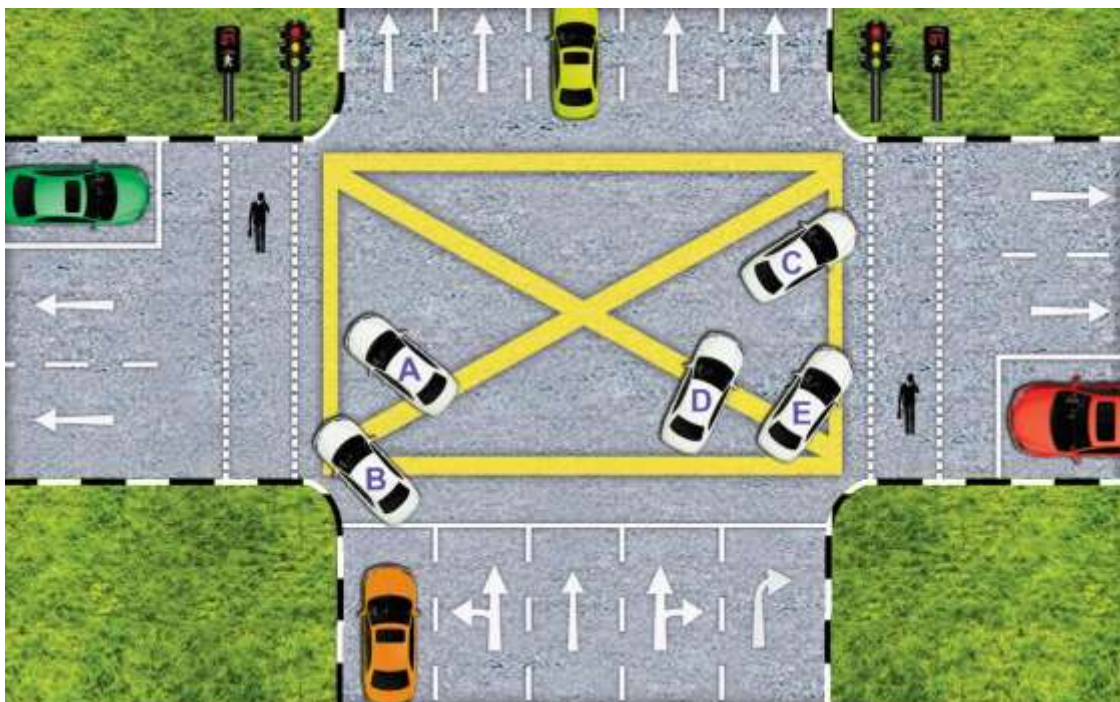



**U-TURNS**

- 95** Do not make a U-turn at any road intersection, junction or any opening in a road divider except where a U-turn sign is located.
- 96** Always negotiate a U-turn carefully, especially if roadside trees or hedges are obstructing your view of oncoming traffic. As you turn, be alert for any vehicles, especially motorcycles, which may be turning together with you on your right.

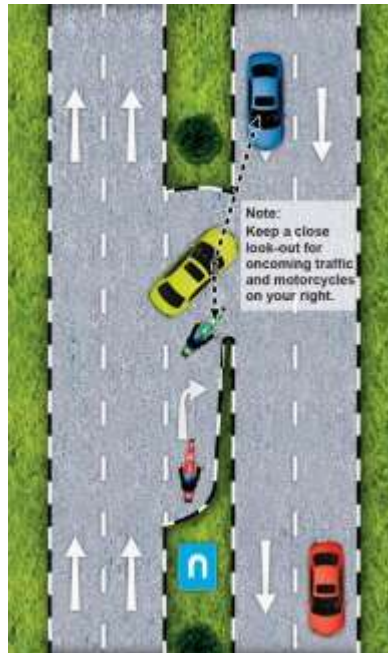

**STOPPING AND PARKING**

- 97** Do not park or let your vehicle wait:
- At a bend, the brow of a hill or a bridge.
  - On a footway or cycle track.
  - Near traffic lights or pedestrian crossings.
  - On a main road or on a road carrying fast moving traffic.
  - Opposite or nearly opposite another stationary vehicle across the road, or other obstructions (eg. road repairs).
  - Abreast of another vehicle.
  - Within 6 metres (20 feet) of an intersection or junction of any road or street (as shown in the diagram below).
  - Within 9 metres (30 feet) of a bus stop (from the edge of a yellow demarcated box or from the tip of a bus bay except when the vehicle breaks down owing to a defect in the vehicle or its tyres).
  - Within 3 meters (10 feet) on either side of fire hydrant.
  - Where it will obstruct any entrance.
  - Facing oncoming traffic.
  - Along any slip road.
  - On a flyover, underpass or ramp leading to a flyover or underpass.
  - On a grass verge or on a road shoulder.
  - In any bus lane.
  - In any designated taxi stop (except taxis).
  - In any taxi stand (except taxis).
  - In any bus terminus (except omnibuses).
  - Within "No Waiting" zone
  - Within "No Stopping" zone

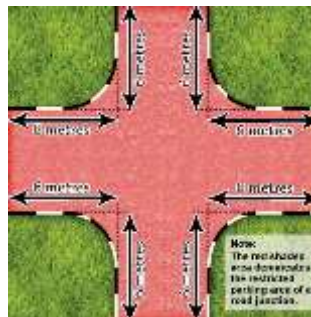

(Note: Parking means to bring the vehicle to a stationary position and cause it to wait other than for the immediate picking up or letting down of passengers.)

- 98** Before opening a door of a vehicle, make sure that it will not endanger or inconvenience anybody on the road or foot-path. Get out on the side nearest to the kerb whenever it is possible.
- 99** When you have to stop, pull in as close as possible to the edge of the road.
- 100** Whenever you park, remember to:
- Turn off the engine and engage the hand-brake.
  - Put your car into reverse gear if facing downhill and into low gear if facing uphill.
  - Remove the ignition key.
  - Lock the steering mechanism or activate the burglar alarm if your car is fitted with one.
  - Wind up the windows and lock the doors.
  - Keep your valuables in the boot or in a place where they cannot be seen.

**101** Remember that you are not allowed to leave any broken-down or wrecked vehicle on any public road. If your vehicle breaks down on the road, push it into a break-down bay or as close to the side of the road as possible. Switch on the hazard warning lights even during daylight and place a reflective warning triangle at least 20 metres behind the vehicle. Arrange for it to be towed away immediately so as not to cause obstruction to the flow of traffic.

**SEAT BELTS**

102 All persons travelling in vehicles, irrespective of their age, should be appropriately belted up. Adults below the height of 1.35m shall use booster seats or approved adjustable seat belts to lower the risk of injury in the event of an accident.



*A seat belt can save your life*

103 A composition fine of \$120 and 3 demerit points will be awarded for failing to belt up.



**LIGHTS**

104 At night (between 7.00pm and 7.00am) you must drive with your headlights on.

105 At night always drive well within the limits of your headlights. Beware of pedestrians standing on the central divider because it is difficult to see them when dazzled by the lights of oncoming vehicles.



Pedestrian is invisible to driver

106 Use dipped headlights at night in built-up areas and during rainy weather.

107 On unlit roads always use your high beam. Dip your headlights when meeting other vehicles and cyclists. If you are dazzled by the lights of another vehicle, slow down and stop if necessary.

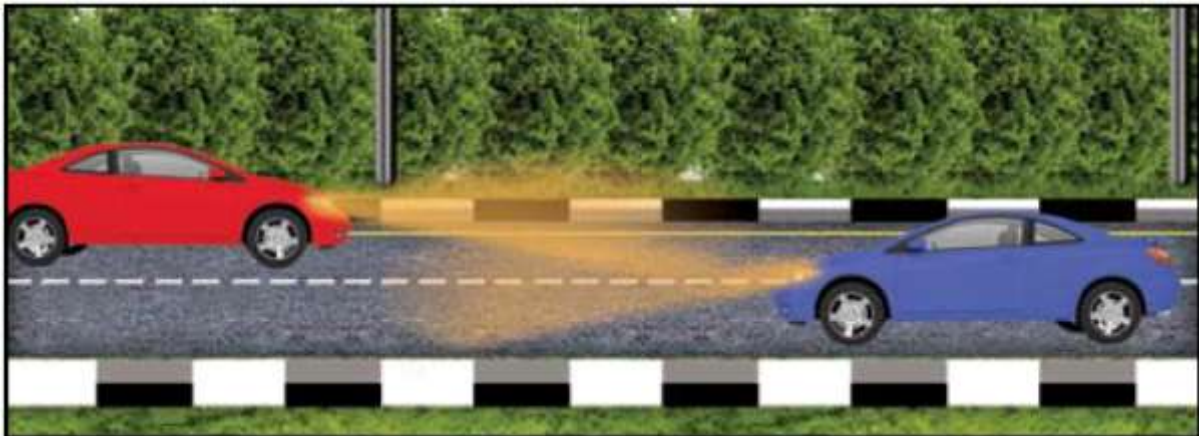

108 Dip your headlights when driving behind other vehicles.

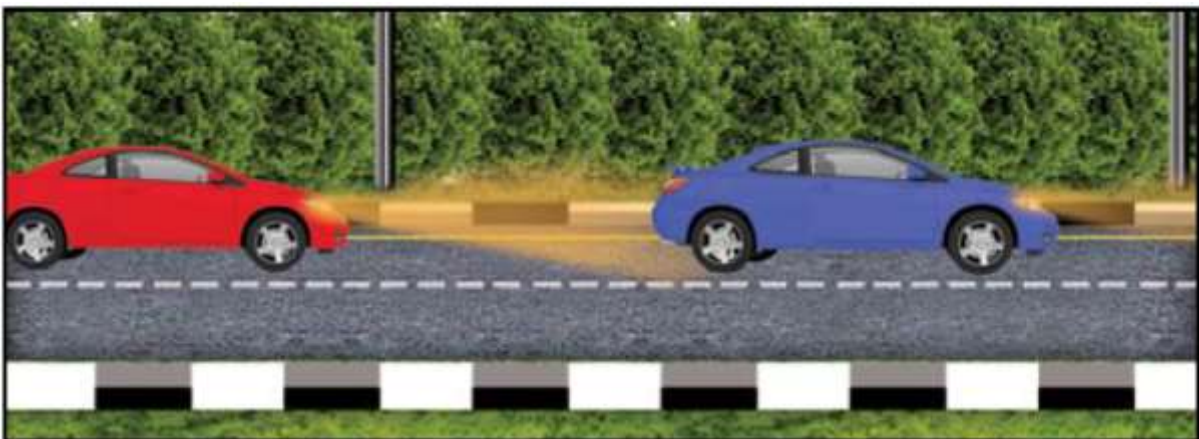

- 109** In the daytime whenever visibility is poor or if it is raining, switch on your headlights. This is to enable other road users to see your vehicle. Switching on your headlights will not in any way affect your fuel consumption.
- 110** It is advisable when parking in unlit or poorly lit roads at night to leave your side or parking lights on.
- 111** Try not to look directly at the headlights of oncoming vehicles but direct your vision slightly to the left. This technique can save you from momentary blindness.
- 112** Always keep a look-out for flashes from the brake lights of vehicles in front.
- 113** When approaching a curve or intersection with poor visibility, it is a good idea to flash your headlights to let pedestrians and oncoming cyclists and motorists know that you are heading into the curve or intersection.
- 114** It is unsafe to drive with the interior lights on as they reduce your external visibility. Motorcyclists are required to switch on their headlights throughout the day.

**ALCOHOL**

- 115** Alcohol, when even a small quantity has been consumed, makes you less safe on the roads. The safe rule is IF YOU DRINK, DON'T DRIVE. The same applies to drugs even when taken medicinally.
- 116** The prescribed legal limit for blood alcohol content is 80 milligrammes (mg) of alcohol per 100 millilitres (ml) of blood while that for breath is 35 microgrammes (ug) of alcohol per 100 millilitres (ml) of breath. Any person caught driving with blood or breath alcohol content which exceeds the prescribed limit will be charged in court for drink driving. A person can also be charged for drink driving even when the blood or breath alcohol content is below the legal limit if there is evidence to show that he/she was unable to control the vehicle because of alcoholic intoxication. The penalty for drink driving is a fine of between \$2,000 and \$10,000 or imprisonment not exceeding 12 months or both. A repeat offender will face a fine of not less than \$5,000 and not more than \$20,000 and imprisonment for a term not exceeding 2 years.

**LIGHT GOODS VEHICLES**

- 117** All lorries used for carrying workers on the carriage deck must be fitted with canopies and higher side railings.
- 118** The load on any vehicle on a road should always be securely fastened.
- 119** The front passenger seat(s) in the lorry's cabin must be occupied before workers can be carried on the rear carriage deck.
- 120** Lorry owners who wish to use their lorries to carry their workers must display a Maximum Passenger Capacity (MPC) label on the right side of the lorry's rear tailboard indicating the maximum number of workers that can be transported when the carriage deck is empty.
- 121** For safety, when workers are carried in lorries, they should be made to sit down properly and the maximum allowable height of a seated worker shall not be more than 1.1 metres measured from the carriage deck.
- 122** The vehicle must not carry an excess number of workers based on the minimum deck space requirement of 0.372 square metres (or 4 square feet) per seated worker. If goods or equipment are also transported, the number of workers that may be carried is to be reduced according to the remaining floor area available.
- 123** When transporting workers on the carriage deck, the vehicle must not travel faster than the posted road speed limit or the vehicle speed limit of 60 km/h, whichever is lower.

**HEIGHT LIMITS**

- 124** Anyone who drives a vehicle with overall height exceeding 4.5m without police escort is committing an offence.

Avoid collision with an overhead structure in 4 steps

- (a) Ensure vehicle height is less than 4.5m. Apply for a police escort if vehicle height exceeds 4.5m.
- (b) Plan your route before driving off.
- (c) Obey speed and height limits.
- (d) Stop and seek alternative route if you:
  - (i) are diverted from your original route
  - (ii) are lost
  - (iii) realise that your route is obstructed by a road structure lower than your vehicle's height during your journey.



**USE OF MOBILE COMMUNICATION DEVICE WHILE DRIVING**

("Use", in relation to a mobile communication device, means to hold it in at least one hand while operating any of its functions)

**125** It is an offence to use a mobile communication devices [including mobile telephone and any hand held devices (e.g. tablets, walkie-talkies, handheld gaming consoles, etc) which are designed or capable of being used for a communicative function) when driving or riding a bicycle or powered assisted bicycle (PAB) on the roads. Should you need to use the mobile communication device while driving, you should drive to a safe place such as a carpark and use it when you are stationary. Communicative function, in this context, refers to any of the following functions:

- (a) Sending or receiving oral or written messages;
- (b) Sending or receiving electronic documents;
- (c) Sending or receiving still or moving images;
- (d) Sending or receiving audio or video files; and
- (e) Providing access to the internet.

**126** Any driver caught using a mobile communication device whilst driving will be charged in court. The penalty for this offence is a fine not exceeding \$1,000 or imprisonment not exceeding 6 months, or both. The offender's driving licence is also likely to be disqualified.

**127** Any cyclist caught using a mobile communication device while riding a bicycle or a powered assisted bicycle can be fined \$75 for this offence.

**128** Typical scenarios of using a mobile communication device while driving includes driving with one hand holding a mobile communication device and communicating with another person on that device while the vehicle is in motion; texting with a mobile communication device, dialling a phone number or pressing a button to receive a call while holding the mobile communication device are also against the law. Using hands free devices, such as wireless or wired headsets, is acceptable unless the driver is holding on to the mobile communication device while using the hands free device while the vehicle is in motion.

In short, an offence is committed if the driver satisfies all the 3 conditions below:

- (a) At least one hand is holding a mobile communication device; and
- (b) Driver is using any function of the mobile communication device; and
- (c) The motor vehicle is in motion.

### MOVING OFF

**129** Before you move off, fasten your seat belt and look in the mirrors. Give the proper signal, look around to check on traffic and pedestrians. Move off only when you can do so safely and without causing inconvenience to other road users. Give way to passing and overtaking vehicles.

### MIRRORS AND SIGNALS

**130** Mirrors should be checked before moving off, slowing down, stopping, changing lane, overtaking and making any turn. You should also cultivate the habit of checking the mirrors every 5 to 10 seconds while driving along.

**131** The areas on the right and left of your vehicle which cannot be viewed in your mirrors are known as “blind spots”. You have to turn your head and look over your shoulder to the left or the right to check for traffic in the “blind spots” before changing lane, overtaking, turning and stopping.

**132** Always give clear signals well in advance of your intentions (at least 3 seconds) before your manoeuvre so that other road users can interact safely.

### DRIVING ALONG

**133** Constantly adjust your speed to the conditions of the road on which you are travelling. Such adjustment will enable you to stop in any emergency without skidding or losing control of your vehicle.

**134** A good driver automatically reduces speed when:

- (a) Entering a built-up area.
- (b) Approaching a school or a stationary bus with children alighting from or boarding it.
- (c) Travelling on narrow winding roads.
- (d) Approaching children who are playing.
- (e) Approaching a bend, brow of a hill, or other obstruction that limits his/her view.
- (f) The road surface is wet.

### TAILGATING

**135** Tailgating, or following too closely behind another vehicle is a dangerous practice. If the vehicle in front stops suddenly, an accident is inevitable since you will not be able to stop in time. Tailgating also makes the driver in front nervous and can cause him/her to be involved in an accident.

### SAFE FOLLOWING DISTANCE

**136** To be able to stop with an appropriate space between your vehicle and the vehicle in front, you must allow at least one car length for every 16km/h of your speed.

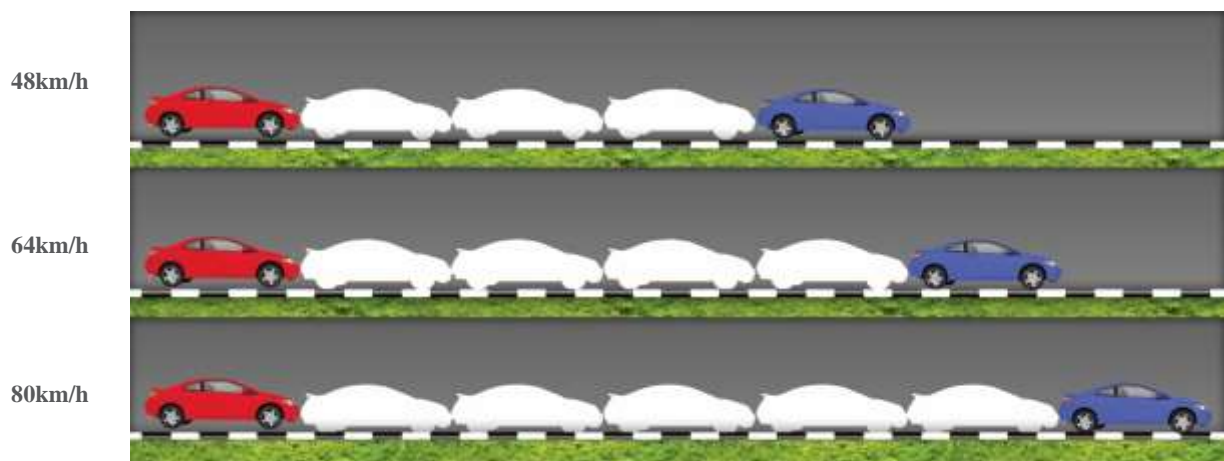

## PART B

### CODE OF CONDUCT ON THE ROAD

### The 'Two-Second' Rule / Stopping Distance

#### THE 'TWO-SECOND' RULE

137 A simple way to ensure a safe gap between you and the vehicle in front is to use the 'two-second' rule. As the vehicle in front of you passes a stationary object, such as a lamp post on the side of the road, start counting to yourself 'one-thousand-and-one, one thousand-and-two'. This will take you 2 seconds. If you reach the same spot before you finish these eight words, you are following too closely and it is necessary to slow down. This rule will keep you at a safe following distance and will apply to all types of vehicles at any speed.



(Vehicle 'A' does not pass the lamp post before counting "one-thousand-and-one, one-thousand-and-two". Thus vehicle 'A' is at a safe following distance from vehicle 'B')

138 Always watch for the brake lights of the car immediately in front and the traffic ahead of the car in front.

#### STOPPING DISTANCE

139 It takes a longer distance to stop a moving vehicle than most people think. It is therefore prudent to study the chart below and remember that your stopping distance is approximately the sum of your reaction distance and braking distance. These distances will increase with the driving speeds of your vehicle.

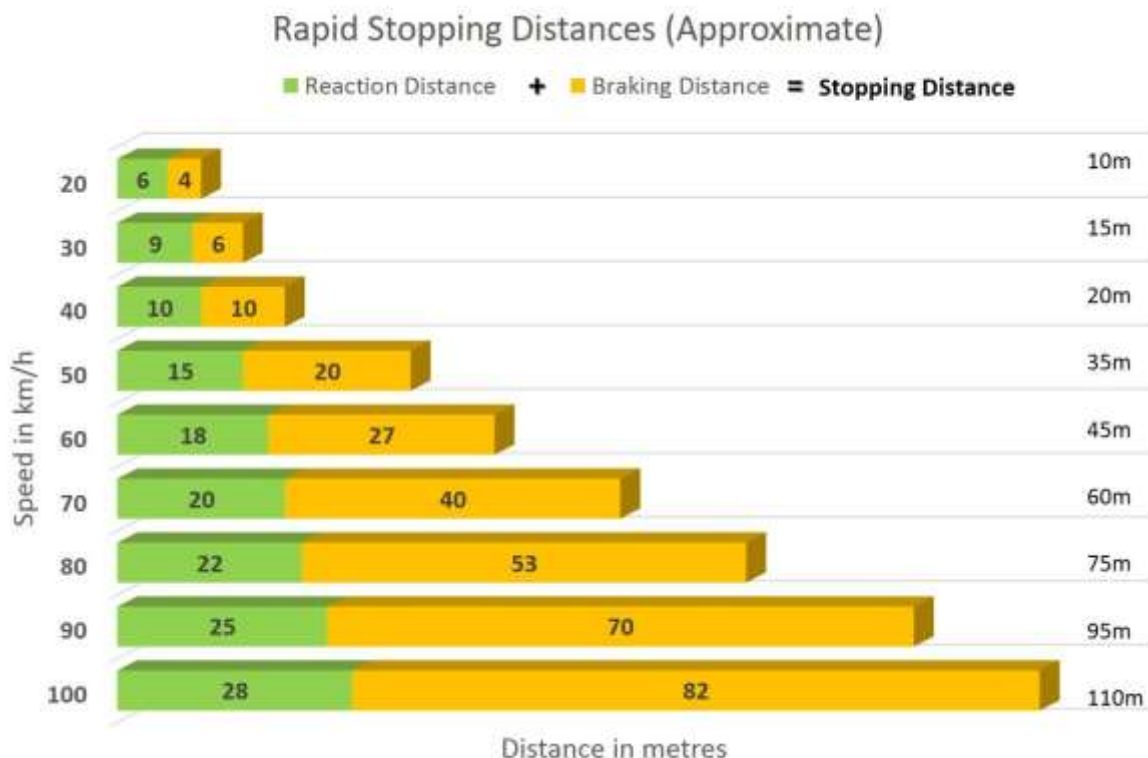

140 The braking distance will also increase when the road is wet, or if the tyre treads are worn, or when the car is fully loaded. Reaction time will also increase if a driver is tired or if he/she has consumed alcohol.

### **REVERSING**

141 Before you reverse, make sure that there are no children or other pedestrians or obstructions in the blind areas behind you.

142 Do not reverse from a side road/minor road into a main road.

143 If your view to the rear is restricted, get help when reversing.

### **SAFETY OF PEDESTRIANS AND CYCLISTS**

144 Pedestrians have the right-of-way at Pedestrian Crossings.

145 When approaching a pedestrian crossing, slow down and do not overtake other vehicles.

146 When approaching a pedestrian crossing, ALWAYS –

- (a) be ready to slow down or stop so as to give way to pedestrians;
- (b) signal to other drivers your intention to slow down or stop;
- (c) allow yourself more time to stop when the road is wet.

147 At a pedestrian crossing controlled by traffic signals or by a policeman, give way to pedestrians who are still crossing even when the signal allows vehicles to move.

148 Stop, when signalled to do so by a school patrol warden showing a “STOP-Children” sign.

149 Watch for pedestrians who come out suddenly from behind stationary vehicles and other obstructions. Be very careful near schools and bus stops.

150 Pedestrians using rural roads tend to be less “road-wise”. Watch out for them.

151 When you are passing a pedestrian, always maintain as wide a distance from him/her as possible and drive slowly.

152 When pedestrians are facing traffic, keep a gap of at least 1 metre from them.

153 When pedestrians are turned away from traffic, keep a gap of at least 1.5 metres from them.

154 Provide a minimum distance of 1.5m when passing cyclists where practicable, just like with another vehicle.

155 Stop behind cyclists when stationary at road junctions. Look out for cyclists turning and give way to them.

156 When driving across a muddy section of the road or through a puddle, you should slow down to avoid splashing muddy water onto pedestrians.

### **EMERGENCY VEHICLES**

157 Ambulances ferry the sick and injured to hospitals. Fire Engines help put out fires, and Police Vehicles carry police personnel whose presence is much needed in an emergency. Obstructing the passage of any such vehicle could mean the difference between life and death for someone, somewhere. If you encounter any of them on the road with sirens and/or seeing the flashing beacon lights, give way by pulling in to the left or right side of the road depending on the circumstances.

#### **DO**

- (a) Pull to the nearest edge of the roadway and come to a complete stop if necessary, until all emergency vehicles have passed.
- (b) Be alert to the approach of an emergency vehicle.
- (c) Switch on your direction signal when pulling off the road. This sends a message to the emergency vehicle operator that the driver is aware of his/her presence.

#### **DO NOT**

- (a) Block any intersection (even when attempting to give way to an emergency vehicle), as it is dangerous.
- (b) Follow closely behind an emergency vehicle responding to an emergency.
- (c) Stop on a bridge, curve or crest of a hill; instead, switch on your directional signal and proceed forward until you can safely pull over and come to a complete stop.
- (d) Slam on your brakes or stop directly in front of an emergency vehicle.

### **GENERAL SAFE DRIVING**

158 When you are driving, keep your attention on the road ahead, except for necessary and frequent glances at the rear view mirror, wing mirrors and panel of the car. Do not turn your head to talk to your passengers or to light a cigarette. Children should not be allowed to obstruct or distract the driver and parents should train them not to do so.

## **PART B**

### **CODE OF CONDUCT ON THE ROAD**

General Safe Driving

**159** Be careful when driving on steel plates laid on unfinished roadworks because these are extremely slippery, especially when they are wet.

**160** Avoid driving through floods as there is a danger that brake malfunction may subsequently occur. If unavoidable, pump the brake pedal repeatedly after emerging from flood waters so as to dry the brakes.

#### **161 HOW TO REACT TO ANIMALS CROSSING THE ROAD**

- (a) Slow down when driving next to nature areas, and where wildlife crossings are indicated.
- (b) Be alert and slow down if you see any animals crossing the road ahead of you.
- (c) Be extra cautious at dawn and dusk as this is the peak period for animal movements.
- (d) Scan the road shoulders ahead of you. Look for reflecting eyes or animals walking along the side of the road.
- (e) Even though animals may be walking along the side of the road as your vehicle approaches, they may panic and attempt to flee by crossing the road. Slow down as you approach.
- (f) If collision with the animal is unavoidable, apply the brakes firmly and remain in your lane.
- (g) If you have a collision with an animal and it is causing an obstruction to other road users; you are required to stop your vehicle, turn on your hazard light and notify the Traffic Police at 999.
- (h) Refrain from touching or moving the injured animal unless you are confident to do so; as it may still be able to defend itself. In the event you are able to move the animal place it at the road shoulder or grass verge ensuring it does not cause any further obstruction to road users. Update Traffic Police at 999 once you have successfully moved the animal.

#### **162 DRIVING ALONG**

- (a) Adjust your speed to the speed of the traffic around you so as not to slow down traffic behind you (road hogging). Even when you are driving on the left hand side of the roadway, do not drive slowly at below 15km/h of the stipulated speed limits of the road.
- (b) It is courteous to give the right-of-way to others when circumstances permit.
- (c) When right-of-way is given to you, it is gracious to show a 'thank you' hand gesture.
- (d) When driving in countries with left-hand drive vehicles, do familiarise yourself with the traffic rules and regulations by reading up on the Highway Code of that country. New drivers are to gradually familiarise themselves with the road conditions in countries with Left Hand Drive if they plan to drive in those countries.

#### **163 SIGNALLING**

- (a) Give appropriate signals early to allow others to act on them in time.
- (b) Cancel your signals when they are not in use so as not to confuse others.

#### **164 USE OF HORN**

- (a) Sound the horn only to warn other road users of dangers such as a likely collision.
- (b) Do not use the horn to express anger or frustration.
- (c) Do not use the horn to demand the right-of-way or bull doze your way through crowded places.
- (d) Sounding your horn when driving is unnecessary, except as a warning. In some areas e.g. near a school or hospital, it is an offence to use the horn, except to avoid an accident.

#### **165 LANE DISCIPLINE**

- (a) Keep to the left of the road and leave the other lanes for other faster moving vehicles to pass safely.
- (b) Keep within your lane. It is inconsiderate to straddle lanes as this would obstruct other vehicles and may lead to traffic being held up.
- (c) Do not weave in and out of traffic lanes as it would cause confusion and danger to others.
- (d) Cutting into the path of other vehicles is discourteous/inconsiderate and likely to cause an accident and road rage.

#### **166 AT ROAD JUNCTIONS**

- (a) Move into the correct lane early at road junctions to let others know your intended direction of travel.
- (b) When making right turns, position your vehicle properly so that it does not hinder oncoming vehicles.

#### **167 IN TRAFFIC QUEUES**

- (a) Stay in queue during traffic hold-ups. Do not jump queue. Jumping queue is discourteous/inconsiderate and would aggravate the traffic jam.
- (b) Leave a gap at the junction to a side road to enable vehicles from the opposite direction to turn right as well as for vehicles from the side road to move out.



**168 OVERTAKING**

- (a) Overtake only when it is absolutely necessary.
- (b) Overtake only when you are sure that there are no other vehicles attempting to pass or overtake you.
- (c) Slow down and keep left when being overtaken to allow the overtaking vehicle to pass quickly.
- (d) Accelerating when others are trying to overtake you is unsafe and discourteous.
- (e) Cutting into the path of another vehicle after overtaking it is discourteous and likely to anger the driver and cause an accident.

**169 FOLLOWING DISTANCE**

- (a) Keep a safe following distance from the vehicle in front so as to allow yourself enough room to stop safely should the vehicle in front stop abruptly.
- (b) Do not harass the vehicle in front by tailgating it. This is a dangerous practice which could easily lead to an accident.
- (c) Flashing your headlights or blasting the horn at slower moving vehicles in front of you is rude.

**170 STOPPING AND PARKING**

- (a) Always stop or park close to the edge of the road.
- (b) Always stop or park at places where you would not cause any inconvenience to other road users.
- (c) Do not stop your vehicle under a shaded spot which is at a distance from a junction while waiting for the traffic signal to change. This is a selfish act and slows down traffic at the junction.
- (d) When parking your vehicle in a parking lot, be considerate by parking your vehicle parallel to and in the centre of the lot.
- (e) Wait for your turn when looking for a parking lot. It is rude to jump queue or force your way into a lot when another vehicle is trying to get into the parking lot.

**171 LIGHTS**

- (a) Do not drive if your vehicle's headlamps, tail-lamps and/or direction indicators are not working.
- (b) Dip your headlights when following other vehicles or when facing oncoming vehicles, so as to prevent dazzling the drivers of other vehicles.
- (c) In the daytime when visibility is poor, you should turn on the headlights so that you can see and be seen more easily.

**172 PEDESTRIANS (ESPECIALLY THE YOUNG AND ELDERLY), CYCLISTS AND MOTORCYCLISTS**

- (a) Give pedestrians (especially the young and elderly), cyclists and motorcyclists plenty of room from your vehicle as they might change direction suddenly.
- (b) Do not sound the horn when you are close to pedestrians as you might scare and cause them to react irrationally, resulting in an accident.
- (c) Do not obstruct pedestrians by stopping on the pedestrian crossing.
- (d) On wet roads, slow down when you are near pedestrians and cyclists so as not to splash them with water from the road.
- (e) It is not safe to pass a cyclist, be patient and wait until it is safe. This should not hold you up for long and it may save the cyclist's life.
- (f) If a cyclist is ahead of you and you want to turn, turn behind the cyclist. Overtaking and cutting off the cyclist is very dangerous. If and when you do need to overtake cyclists, always ensure that there is ample room from your vehicle when overtaking (this is especially so for drivers of heavy or large vehicles), and do not merge sharply into lanes.
- (g) Always check your blind spot before changing lanes, making turns or moving from a stationary position.
- (h) Always check for cyclists before opening the vehicle door.
- (i) Signal early to inform other road users and cyclists of the direction in which you are heading.
- (j) When approaching road crossings, look out for cyclists and pedestrians.
- (k) Always stop to render assistance and exchange particulars when involved in an accident.
- (l) Do not expect cyclists to cycle all the way to the left next to the kerb, because their pedals may hit the kerb and there are usually drain holes at the side where their tyres could get stuck in and cyclist could lose balance.

**173 PATIENCE**

- (a) Always be patient. Do not rush or lose your cool on the road.
- (b) It is not gracious to show any provocative gesture when other drivers do something wrong or cause inconvenience to you. No one would deliberately get himself/herself involved in an accident.

**174 TO ERR IS HUMAN; APOLOGISE AND FORGIVE**

Indicate that you are sorry when you have caused inconvenience to others. This will soothe the other driver.

## PART B

### CODE OF CONDUCT ON THE ROAD

Safe Driving Technique (Defensive Driving Technique)

#### SAFE DRIVING TECHNIQUE (DEFENSIVE DRIVING TECHNIQUE)

**175** Safe/Defensive driving technique:

Driving safely and competently demands the total involvement of most of your senses. It is not enough to gain physical mastery of the vehicle without cultivating an awareness of the environment. A good driver can interpret, anticipate and act unhesitatingly under adverse driving conditions.

**176** Adverse conditions include:

- (a) Driver conditions
- (b) Weather conditions
- (c) Light conditions
- (d) Road conditions
- (e) Traffic conditions

#### 177 DRIVER CONDITIONS

Your physical and mental condition can affect your driving. These conditions are:

- (a) Your vision,
- (b) Your physical health,
- (c) Your mental state,
- (d) Consumption of alcohol and drugs.

**178** Eighty percent (80%) of information perceived while driving comes through the driver's eyes. It is therefore important that you make optimal use of your eyes when driving. Do not fix your eyes on a particular object for longer than necessary. Keep moving your eyes about every two seconds or so. Also, take regular glances at the rear view mirrors every five to ten seconds so that you are aware of the changing situation around you. As the vehicle speed increases, your field of vision would be reduced.

**179** Tiredness, giddiness and being unwell can affect your concentration on the road. If you feel unwell or tired, do not drive.

**180** Anger, worry and stress can also reduce concentration and may lead to rash or careless driving on the road.

**181** Consumption of alcohol and certain types of drugs affect your judgement, concentration and reaction time. If you are on medication, check with your doctor whether the prescribed medicine you are taking will affect your driving ability. If so, do not drive. It is also unsafe for you to drive if you have consumed alcohol.

**182** It is an offence for a person to drive or attempt to drive a vehicle while under the influence of alcohol. If a driver is suspected to be under the influence of alcohol, he/she will be required to undergo a breath analyser test. A person with a BAC (Blood Alcohol Concentration) exceeding 80mg per 100ml of blood is presumed incapable of controlling his/her vehicle properly.

#### 183 WEATHER CONDITIONS

Adverse weather conditions affect your ability to see and be seen. These conditions are:-



RAIN



FLOOD



STRONG WINDS

**184** The basic rules to follow when driving in bad weather conditions are:

- (a) Reduce your speed so that you can manoeuvre safely.
- (b) Do not out-drive the actual distance that you can see clearly.
- (c) Switch on your headlights so that you can see more clearly and be more visible.
- (d) Turn on the demister to clear the mist on the windscreen.
- (e) Move to a safe spot and stop at the side of the road with your hazard lights turned on if you cannot see clearly. Proceed when conditions are favourable.
- (f) Use a faster front windscreen wiper speed when driving in heavy rain.

**185** On a wet road, the stopping distance of a vehicle will increase to about twice the distance of that on a dry road. This is because there is less friction between the tyres and the wet road surface. On a wet road, stepping hard on the brake pedal (locking the wheels) will cause the vehicle to skid or spin. If you lock the wheels accidentally, quickly release the brake pedal and apply the intermittent (ON/OFF) braking technique until the vehicle comes to a stop. Thus, on a wet road, it is important that you drive at a slower speed to avoid such dangerous circumstances.



**186** On a rainy day, a thin layer of water forms on the road surface. Even good tyres may not have a good grip on the road. As speed increases, surface water builds up under the vehicle's tyres. When this happens, your vehicle will glide on the surface of the road, and this is known as 'Aquaplaning'.

**187** Aquaplaning results in the loss of steering control and braking efficiency. The faster you go, the more difficult it will be to control the vehicle. To counter this, you should slow down by braking intermittently (on/off braking) until you gain control of your vehicle.



**188** When approaching a road that is flooded but passable to vehicles, engage a lower gear to go through the flood

**189** After passing through water, the brakes become ineffective. To dry the brakes, pump the brake pedal repeatedly until braking action returns.



**190** You can also dry the brakes by gently depressing the brake pedal with your left foot while pressing the accelerator with the right foot.

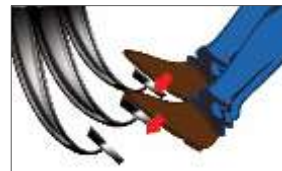

**191** At night, the depth of flood water can be deceptive. If in doubt, take an alternative route.

**192** Stretches of open highways are usually subjected to strong winds. To avoid the danger of being forced into the path of other traffic by the wind, you should slow down and drive cautiously.

### **193 LIGHT CONDITIONS**

Too much or too little light will affect our ability to see. Sun-glare or light reflected off objects or a pool of water on the road can dazzle and even blind our vision. You should wear sunglasses or lower the sun-visor when it is very bright.



**PART B**

**CODE OF CONDUCT ON THE ROAD**

**Safe Driving Technique (Defensive Driving Technique)**

194 Switch on your headlights from 7pm to 7am. Drive at a slower speed than you would during the day.



195 When the headlight of an oncoming vehicle dazzles you, look to your left to avoid the glare. Use the edge of the road to guide your vehicle. If the light is blinding, slow down and stop by the side of the road.



196 When facing oncoming traffic, dip your headlights.



197 Dip your headlight when you are immediately behind another vehicle. If not, the beam from your headlight will be reflected by the rear view mirror of the car in front and dazzle the driver.





## PART B

### CODE OF CONDUCT ON THE ROAD

### Safe Driving Technique (Defensive Driving Technique)

198 On approaching bends where visibility is poor, use your high beam. This will attract the attention of other road users and warn them of your approach.

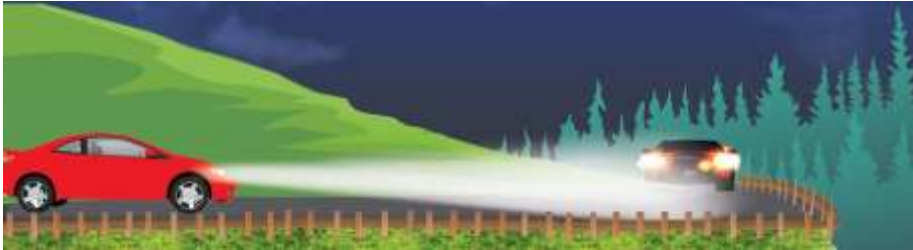

199 It is safer not to out-drive your normal headlight range. The average headlight on high beam is about 100 metres.



### 200 ROAD CONDITIONS

A good driver should know how to read and adjust his/her speed accordingly to suit the road conditions, such as:

- (a) The width of the road;
- (b) The kind of road surface he/she is driving on;
- (c) The contour of the road;
- (d) The possible danger of hazards ahead.

201 On a sandy or pebbled surface, there is a greater risk of 'side slipping'. Try to avoid hard acceleration, braking and sudden sharp turning of the steering wheel.



202 If the rear of your vehicle skids side way, remove the foot from the accelerator at once. Never apply the brakes during a skid correction, steer in the direction of the skid.



(a) On roads with uneven surfaces, drive slowly.



(b) If you encounter large pot-holes, reduce your speed further and proceed slowly.



203 When driving round a bend or sharp corner at high speed, your vehicle tends to be pushed out of its path of travel by a force called the Centrifugal Force.



204 The greater the travelling speed around the curve or the sharper the curve, the more the vehicle will be pushed from its path. You should therefore reduce speed when going round a bend. The diagram on the right shows the appropriate speed and the dangerous speed for each turning radius.

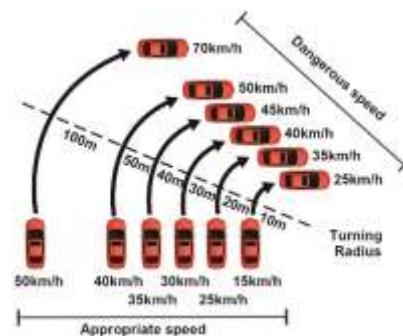

**205 TRAFFIC CONDITIONS**

Traffic conditions vary depending on time, place and situation. Traffic may be congested or relatively light. The speed of other vehicles also varies. Try to drive with the traffic in order not to disrupt its flow.

206 Adjust your speed to the traffic and road situation. Situations change as you travel from urban built-up areas to sub-urban and then to rural areas.



**URBAN**



**SUB-URBAN**



**RURAL**

207 In urban areas, traffic is slow and heavy. Traffic is faster and lighter in suburban areas. In rural areas, traffic is generally light. Whatever the traffic conditions, the driver has the responsibility to be careful and alert at all times.

**208 DRIVING OVERSEAS**

Most countries in Europe adopt a left hand drive system, ie. you'll find the steering wheel on the other side of the car.

For more information on overseas driving tips, please refer to the Automobile Association of Singapore's website. Being prepared will allow you to drive more confidently.

**STOPPING AND MOVING OFF AT TRAFFIC LIGHT JUNCTIONS**

**209 (a) WHEN STOPPING**

DO's	DON'Ts
<ol style="list-style-type: none"> <li>1. Stop before and close to the stop-line.</li> <li>2. Leave a safety gap of 2 metres between your vehicle and the vehicle in front.</li> <li>3. Apply the handbrake after stopping.</li> <li>4. Be alert to the traffic around you while waiting for the lights to change.</li> <li>5. Position your vehicle in the centre of the lane.</li> </ol>	<ol style="list-style-type: none"> <li>1. Stop beyond or too far from the stopline.</li> <li>2. Stop less than 2 metres behind the vehicle in front.</li> <li>3. While waiting for the lights to change,                         <ol style="list-style-type: none"> <li>a. read newspapers, magazines, etc.</li> <li>b. sip drinks,</li> <li>c. adjust the car audio system,</li> <li>d. use the car-phone,</li> <li>e. rev the engine.</li> </ol> </li> <li>4. 'Inch' forward while waiting for the lights to change.</li> <li>5. Stop under shades which are far from the junction.</li> <li>6. Allow passengers to alight or board your vehicle.</li> <li>7. Stop suddenly.</li> </ol>

**(b) WHEN MOVING OFF**

DO's	DON'Ts
<ol style="list-style-type: none"> <li>1. Move only when the lights turn 'green'.</li> <li>2. Look to the right and left for approaching vehicles before moving.</li> <li>3. Look out for pedestrians crossing the road in front of you.</li> <li>4. Wait 2 secs after the vehicle in front has moved off, before proceeding.</li> <li>5. Proceed only in the direction indicated on the lane.</li> <li>6. Give way to vehicles beating the lights.</li> </ol>	<ol style="list-style-type: none"> <li>1. Move off before the lights change even though there are no approaching vehicles.</li> <li>2. Accelerate harshly.</li> <li>3. Move before it is safe to proceed.</li> <li>4. Change your direction of travel.</li> <li>5. Overtake slow moving vehicles in front of you.</li> <li>6. Weave past pedestrians crossing the road.</li> </ol>

**ROADWORTHINESS**

**210** Maintain your vehicle in a roadworthy condition. You should pay attention to the following matters in regard to maintenance, which if attended to, could prevent accidents.

**(a) Tyres**

Keep your tyres up to the correct pressure. Tyres that have treads less than 1.6mm in depth should be replaced. Smooth or bald tyres will cause skids when you brake hard in an emergency, whether the road is wet or dry.

**(b) Brakes**

Have the brake system checked regularly, particularly hydraulic brakes, for any leakage of brake fluid may indicate that a serious fault is developing.

**(c) Steering**

The steering assembly of your car should be regularly checked and kept in good condition. Check for vibration or too much looseness in the steering mechanism or wheels that are out of alignment. A car that wanders on the road because of faulty steering is as dangerous as a car being driven by a drunk driver.

**(d) Lights**

Check all your vehicle lights regularly.

**(e) Direction Indicators**

Keep your signalling devices in order by checking them frequently. Signal lights that do not light up when required may cause an accident.

**(f) Horn**

Check your horn to make sure it is in working order.

**(g) Radiator Coolant**

Check the level of coolant in the radiator regularly. Most modern cars come with a coolant reservoir and the correct coolant level should be somewhere between the 'high' and 'low' indicator markings. Checking should be done when the engine is cool especially for cars without coolant reservoirs. Coolant in the radiator is highly pressurised when hot and releasing the radiator cap may drench you with boiling liquid. Ensure that the engine is cool before opening the radiator cap.

**(h) Engine Oil**

Keep enough oil in the engine and have the oil changed periodically. Check the oil level with the help of the dip-stick.

**(i) Windscreen Wipers**

Make sure that your windscreen wipers are kept in good condition. Dirty windscreens and faulty wipers will hinder vision when it rains.

## PART B

### PARTS AND CONTROLS OF A CAR

Front View / Rear View

#### (j) Battery

Keep the battery and its terminals clean. Make sure that the connections at the terminals are securely tightened. Check the level of the battery water if your battery is not the maintenance-free type. If the water level is below the 'low' level, add distilled or commercially available battery water. Refilling with tap water will shorten battery life considerably.

#### (k) Exhaust

All vehicles must be maintained in a condition and be driven in a manner so as to eliminate excessive emission of smoke and noise. Smoke and noise are a nuisance and hazardous to health. Check the exhaust system regularly. If exhaust fumes leak into the passenger compartment, especially if the car is idling with its air-conditioner on, it can be dangerous as there is a likelihood of carbon-monoxide poisoning.

### FRONT VIEW



### REAR VIEW

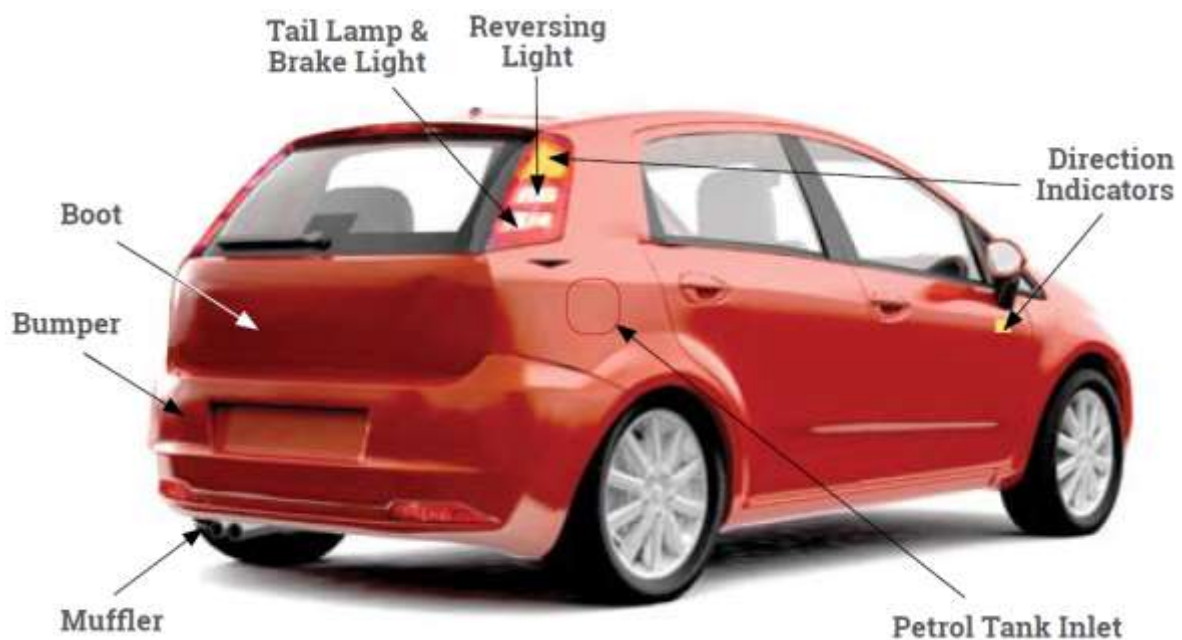

**THE INSTRUMENT PANEL (DASHBOARD)**

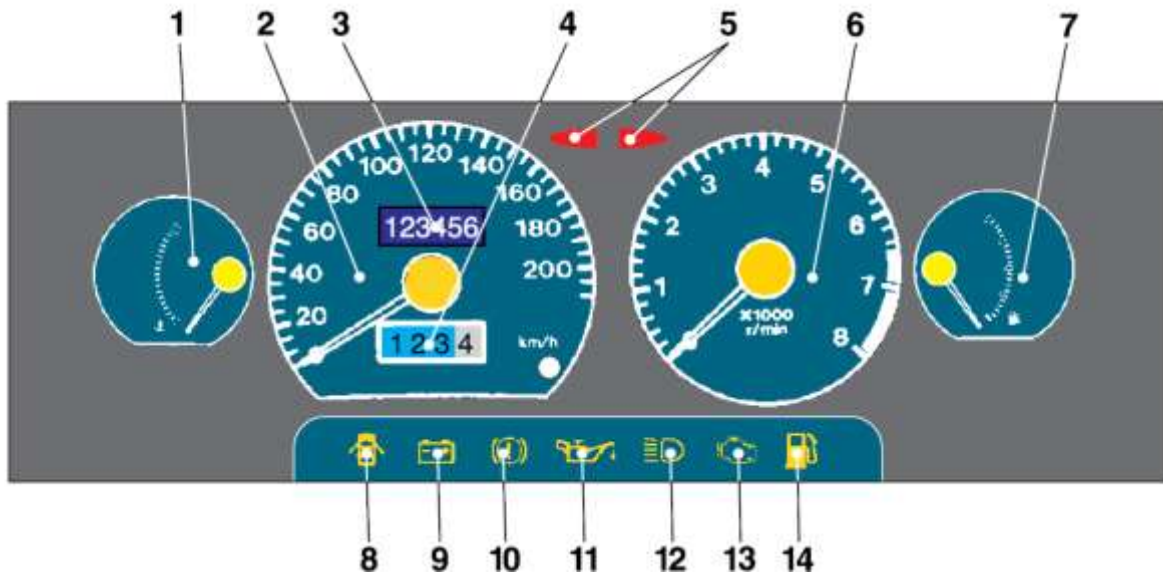

- |  |                                  |
|--|----------------------------------|
| 1 Temperature Gauge                          | 8 Door Ajar Warning Light        |
| 2 Speedometer                                | 9 Battery Warning Light          |
| 3 Odometer                                   | 10 Hand Brake Indicator          |
| 4 Tripmeter                                  | 11 Oil Pressure Indicator        |
| 5 Signal Indicators / Hazard Light Indicator | 12 High Beam Indicator           |
| 6 Tachometer                                 | 13 Engine Check Light            |
| 7 Fuel Gauge                                 | 14 Empty Fuel Tank Warning Light |

**NAMES OF VARIOUS DRIVING CONTROLS**

- 1 Wiper Switch
- 2 Steering Wheel
- 3 Horn
- 4 Direction Indicator Switch
- 5 Accelerator Pedal
- 6 Brake Pedal
- 7 Clutch Pedal
- 8 Handbrake
- 9 Gear Lever

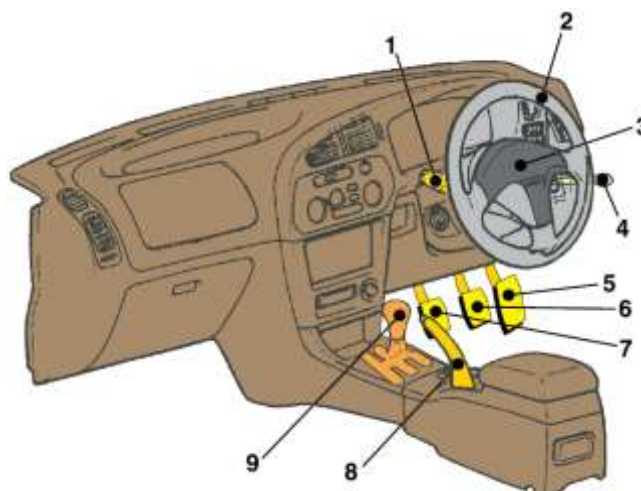



**ROAD USERS AT WORK ZONES**

**Motorists, Motorcyclists or Cyclists**

211 Take special care to watch out for the warning of the work activity and the obstruction ahead. Be alert of the traffic situation around you.

212 Observe the orange warning and information signs that are to help you. You must not exceed any temporary maximum speed limit posted at the work zone for your safety.

213 Get into the correct lane in good time. Do not switch lanes to overtake queuing traffic or move through an area marked off by traffic cones or barriers.

214 Be careful not to get into the path of traffic entering or leaving the work area. Do not be distracted by the activity in the work area. Concentrate on the road ahead and keep a safe distance from the traffic in front.

**Pedestrians**

215 Keep away from the work area. Do not enter the work area for convenience or a short cut.

216 Follow the direction sign for the alternative path provided when the footpath is blocked. Do not walk along the traffic lane if it is not designated and cordoned off for pedestrians.

**WORK ZONE SIGNS**

217 These signs are displayed along the work zone, the section of the road affected by a work activity where temporary traffic control is exercised. These signs contain a black symbol or message with or without a logo on an orange background and are either diamond-shaped for warning or rectangular-shaped for information to the road users. Lateral shift markers are work zone signs that indicate a lateral change in direction of the carriageway or a sharp bend in a road diversion through the work zone.

218 Typical examples of work zone signs are illustrated below:



Caution Road Users



Works Ahead



Road Narrows on Left



Road Narrows on Right



Left Lane Ahead Closed



Right Lane Ahead Closed



Centre Lane Ahead Closed



Hazard Ahead





Work Access Ahead



Left Bend Ahead



Right Bend Ahead



Lateral Shift Marker  
(Indicates a lateral change of direction)



Series of Bends Ahead



Shoulder Lane Closed Ahead



Pedestrian Path



Indicates Location  
(To supplement another sign)



Distance Supplementary Plate  
(To supplement warning signs)



Project Information



Start of Work Zone

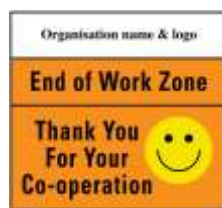

End of Work Zone



Project Information  
(example)

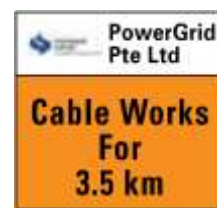

Start of Work Zone  
(example)

## PART B

### DRIVING IN SPECIAL ZONES

School Zone / Silver Zone

#### SCHOOL ZONE SAFETY

**219** Children are vulnerable road users with limited experience using the roads, thus it is of paramount importance to keep school zones safe.

#### ROAD SAFETY MEASURES

**220** Several road engineering measures have been installed in school zones to enhance safety. These include:

- Prominent school zone signs that remind motorists to drive carefully
- Traffic calming measures such as road humps
- Pedestrian crossings
- Parking restriction lines
- Railings along the road centre to deter jaywalking
- Parts of the road surface near the school gate are covered with a red texture to catch drivers' attention and alert them to drive carefully and to look out for children crossing the road.



#### DRIVING IN SCHOOL ZONES

- 221**
- Slow down and drive very carefully when you are in a school zone.
  - Be extra vigilant in watching out for children crossing the road as they may be easily blocked from your view due to their height.
  - Be patient when you encounter heavy traffic at school zones during school peak hours. If you are rushing for time, please take other routes if you can.
  - If you drive your child to school, let him/her alight at safe and proper drop-off points.

#### SILVER ZONE SAFETY

**222** Silver zones are designated areas with enhanced road safety engineering measures such as new signs, road features and markings to change the character of the street, making it safe and more convenient for senior pedestrians to cross the road.

**223** Silver zones are found in selected housing estates with high senior populations, relatively higher accident rates involving senior and proximity to places where seniors frequent.

**224** With effect from 1 July 2021, the punishments for specified traffic offences will be enhanced when they are committed within the Silver and School Zones to strengthen deterrence against irresponsible driving. The enhanced penalties include additional 2 demerit points and \$100 composition fines on top of the original demerit points / fines, subject to the total fine not exceeding \$500.

#### ROAD SAFETY MEASURES

**225** Several road safety engineering measures have been installed in silver zones to enhance road safety for all road users, senior pedestrians in particular. These includes:

- Silver zone gateway treatment which includes signs and road markings to indicate the start of a silver zone.



- Setback crossings to provide reduced crossing distance for pedestrians.
- 2-stage crossings so that pedestrians can rest momentarily at the pedestrian refuge (centre divider) before continuing to cross the road
- Centre divider to narrow lanes and reduce vehicles' travel speeds.
- Traffic calming measures such as chicanes and eye-lands (horizontal curves constructed along existing straight stretches of roads), pinch points (narrowed lanes to slow motorists down) and bus-friendly humps.
- Silver zone bollards at crossings to highlight the crossing points.

## PART B

### DRIVING IN TUNNELS

- (g) 3D road markings to narrow lane width virtually and reduce vehicles' travel speeds.



### DRIVING IN SILVER ZONES

- 226 (a) Drive slow and carefully within silver zones, especially when approaching crossings.  
(b) Be extra vigilant in watching out for all pedestrians, especially senior pedestrians crossing the road.  
(c) Be patient when you encounter senior pedestrians crossing within silver zones as they may require a longer crossing time.

### DAILY DRIVING RULES

227 The following is a list of **Do's** in the tunnel:

- (a) Plan your route well in advance;
- (b) Turn on the vehicle headlights;
- (c) Turn on the radio;
- (d) Follow the traffic signs;
- (e) Heavy vehicles to keep left;
- (f) Stay in lane;
- (g) Insert cash card in advance for ERP payments.

228 The following is a list of **Don'ts** in the tunnel:

#### Existing Rules

- (a) Do not stop your vehicle unless in the case of an accident, breakdown, emergency or when lawfully required to do so;
- (b) Do not make any U-turns or reverse your vehicle.

#### Tunnel-Specific Rules

- (a) Do not alight from your vehicle unless in an emergency;
- (b) Do not use your horn except in an emergency;
- (c) Do not change your tyre or wheel;
- (d) Do not refuel or repair your vehicle;
- (e) Do not overtake;
- (f) Do not tailgate;
- (g) Do not speed.

229 The following is a list of vehicles which are prohibited in the tunnel:

- (a) Vehicle which is not carrying sufficient fuel in its fuel tank;
- (b) Vehicle carrying animals or poultry which are not properly controlled or confined, or carrying garbage, fine particles or other similar materials which are not sufficiently covered;
- (c) Vehicle with a load or the cover of the load not properly secured;
- (d) Vehicle carrying a person standing on the outside of the vehicle or seated with any part of his/her person overhanging the sides or rear of the vehicle;
- (e) Vehicle whose overall height is 4.5 metres or above;
- (f) Vehicle whose overall width exceeds 3 metres;
- (g) Vehicle whose overall length exceeds 13 metres;
- (h) Vehicle which is carrying hazardous materials;
- (i) Trailer conveying a standard container;
- (j) Tanker carrying diesel fuel;
- (k) Motorcycles with side cars attached, invalid carriages, three-wheeled vans, low trailers, concrete trucks, cranes, excavators, road pavers, tractors, dumpers, wheel loaders, bulldozers, graders, mobile concrete pumps or hydrant dispensers;
- (l) Vehicle with speed limit of 40km/h and below.

230 Vehicles which have a speed limit of 60km/h and below shall be driven along the left lane of the expressway.

## PART B

### AUTONOMOUS VEHICLE (AV)

#### INTRODUCTION

- 231 An AV is a vehicle that can drive from a starting location to a pre-determined destination using various technologies and sensors to sense its environment and navigate in autonomous mode.
- 232 As part of the long-term vision of deploying autonomous vehicles and shared-mobility concepts to complement our multi-modal land transport system in Singapore, the Land Transport Authority (LTA) started facilitating AV trials in July 2015 at one-north. The AV test-bed area was recently expanded to neighbouring areas such as the National University of Singapore, Singapore Science Park 1 and 2, Dover and Buona Vista. For public notification, signboards are put up in the test areas to indicate that trials are being carried out.



#### HOW TO RECOGNISE AN AUTONOMOUS VEHICLES ON TRIAL?

- 233 AVs that are approved by LTA for the purpose of trials on public roads are issued with permits and sport decals for easy recognition by road users.



#### HOW TO INTERACT WITH AN AUTONOMOUS VEHICLE ON TRIAL

- 234 A good driver is not merely one who is skilful in handling his/her vehicle competently but more importantly is one who is safe. In addition, a good driver must also be patient, considerate and courteous. He must have a sense of responsibility for the safety of other road users and the ability to concentrate, anticipate and react appropriately while driving.
- 235 Safe driving calls for total awareness of what other road users are doing. The correct attitude towards driving will make the road a safer and more pleasant place.
- 236 When you notice an AV being tested on the road, you should continue driving safely as you would normally do. You are advised to observe these simple driving practices:
- Do not tailgate**
    - Tailgating, or following too closely behind another vehicle is a dangerous practice. If the front vehicle stops suddenly, an accident is inevitable since you will not be able to stop in time.
  - Maintain a safe following distance**
    - Drive at a steady speed and avoid unnecessary acceleration or braking.
    - Maintain a safe distance between your vehicle and the AV so that you will have more time to react if necessary.
  - Overtake only if necessary**
    - Never overtake unless you can do so without endangering yourself or others. Similar to overtaking any other vehicles, you need to check that it is safe to do so and leave a safe gap between your vehicle and the AV when overtaking.
    - After overtaking, return to the appropriate lane on the road as soon as it is safe to do so, but do not cut in sharply in front of the vehicle you have just overtaken.

## **PART B**

### **ELECTRIC MOTORCYCLE (EM)**

---

#### **INTRODUCTION**

**237** Electric powered motorcycles and scooters are plug-in-electric vehicles with two or three wheels. The electricity is stored on board in a rechargeable battery, which drives one or more electric motors.

**238** Electric powered motorcycles and scooters are generally of the same size and weight and are comparable in performance with petrol driven motorcycles.

#### **FEATURES OF ELECTRIC MOTORCYCLES**

**239** The features of the electric motorcycles are similar to the petrol engine motorcycles. They generally have the same operating function such as brakes, mirrors, lights and etc.

**240** The only difference is that electric motorcycle runs on automatic transmission gear without having the clutch which is used for manual transmission motorcycles. Similarly, some petrol engine motorcycles and scooters presently runs on automatic transmission.

**241** Electric motorcycles have better acceleration as they develop higher torque. Generally electric motorcycles weigh lighter and have a low engine noise.

#### **CLASSES OF DRIVING LICENCES**

**242** The following table is the categorisation of electric motorcycles with existing Class 2B, 2A and 2 categories under the law.

<b>Licence Class</b>	<b>Categorisation for Petrol Motorcycles</b>	<b>Categorisation for Electric Motorcycles</b>	<b>Existing Driving Licensing Requirements</b>
<b>Class 2B</b>	Below 200cc.	Below 15kW.	Pass the Basic Theory Test, Riding Theory Test and Class 2B practical driving test.
<b>Class 2A</b>	Between 200cc and 400cc.	Between 15kW to 25 kW.	Possess a valid Class 2B licence for at least one year, and pass the Class 2A practical driving test.
<b>Class 2</b>	Above 400cc.	Above 25kW.	Possess a valid Class 2A licence for at least one year, and pass the Class 2 practical driving test.

#### **ADAPTING TO ELECTRIC MOTORCYCLE**

**243** Although the electric motorcycle features and operations are quite similar to petrol engine motorcycles, riders should accustom themselves with the electric motorcycle faster acceleration. The general road safety rules should be when riding the electric motorcycle.



## **PARKING IN URA/HDB CAR PARKS**

### **244 Coupon Parking System**

- (a) Please read the car park signboard carefully when parking your vehicle at any HDB or URA car park. Besides the car park signboard, motorists are advised to look out for other parking restrictions signs within the car park.
- (b) The car park signboard, which is located either at the entrance of each car park or along the public road, will indicate the different parking schemes, their operating hours and parking rates available in the car parks.
- (c) Sufficient coupons must be displayed to cover the parking period. The relevant tabs must be torn off completely to indicate the date and start time of parking the vehicle.
- (d) Displaying a coupon with any irregularity which indicates that the coupon has been tampered with (e.g. tabs with folded/creased marks) is a serious offence. Such offences are chargeable in Court.
- (e) Parking coupons can be purchased from authorised sales outlets.

### **245 Electronic Parking System**

- (a) Some HDB/URA car parks use the Electronic Parking System (EPS). With EPS, parking charges are on a per-minute basis.
- (b) For short-term parking, the system reads the In-Vehicle Unit (IU) numbers of the vehicles entering the car park. Payment of parking charges can be through cash card or EZ-link card.
- (c) For season parking, the system captures the IU numbers of the season parking ticket holder's vehicle for identification, to allow the vehicle to enter and leave the car park.
- (d) For more information, please visit [www.hdb.gov.sg](http://www.hdb.gov.sg) or [www.ura.gov.sg](http://www.ura.gov.sg).

## **CAR PARK SIGNBOARDS**



**URA Coupon  
Parking Signboard**



**URA Coupon  
Parking Signboard  
(for motorcycles)**



**HDB Coupon  
Parking Signboard**



**Directional Sign  
in the car park**



**Restriction Sign**  
(No parking of  
heavy vehicles such  
as lorries,  
buses, coaches etc)



**Signboard on parking  
restrictions**

**PART C**  
**PARKING IN URA/HDB CAR PARKS**

246 (a) Signboards In Housing & Development Board (HDB) Car Parks

**Signboard 1 (Left):**

- Car Park Number:** TPTFMB
- Night Parking:** From 10.30pm to 7am (Illuminated Signboard)
- Coupon Parking:** Whole Day (24 hours in Short-Term Parking Lots)
- Parking Charges:**
  - 60¢ per 1/2 hr or \$5 per night (10.30pm - 7am) for cars
  - 65¢ per day (7am - 10.30pm) or 65¢ per night (10.30pm - 7am) for motorcycles
- Park & Ride:** (For illuminated Cars Only) 7am - 3pm (Mon - Fri) 7am - 3pm (Sat)
- Free Parking:** Sunday & Public Holidays 7am to 10.30pm

**Signboard 2 (Right):**

- Car Park Number:** BDB43
- Coupon Parking:** 7am - 10.30pm (No Coupon Parking from 10.30pm to 7am)
- Parking Charges:**
  - 60¢ per 1/2 hr for cars
  - 65¢ per day for motorcycles
- Reserved for Season Parking Only:** 10.30pm to 7am (Whole Car Park Reserved for Season Parking from 10.30pm to 7am: No Night Parking for Non-Season Parking Ticket Holders)
- Free Parking:** Sunday & Public Holidays 7am to 10.30pm (Free Parking on Sundays & Public Holidays from 7am to 10.30pm in Short-Term Parking Lots)



Reserved for Season Parking from 7pm to 7am Daily  
Coupon Parking from 7am to 7pm



Reserved for Season Parking from 7pm to 7am on Mondays to Saturdays and Whole Day on Sundays and Public Holidays  
Coupon Parking from 7am to 7pm on Mondays to Saturdays only

(b) Signboards In Urban Redevelopment Authority (URA) Car Parks

**URA Coupon Parking Signboard:**

- URA Coupon Parking Signboard:** (Top section with 'P' and 'Coupon Parking')
- Parking Operation Hours and Charges for Motorcars:**
  - CAR Day & Night Parking 8.30am - 10.00pm
  - 60¢ 1/2 Hourly Monday - Saturday
- Parking Operation Hours and Charges for Motorcycles:**
  - MOTORCYCLE Day & Night Parking 8.30am - 10.00pm
  - 65¢ Per Day Monday - Saturday
- Free Parking:** On Sunday / Public Holiday
- No Parking Of Bus And Lorry:** (Bottom section)

## PART C

### PARKING IN URA/HDB CAR PARKS

---

#### (c) Line Markings For Parking Lots



##### Lots Demarcated in Red

- Reserved for Season Parking Ticket Holders

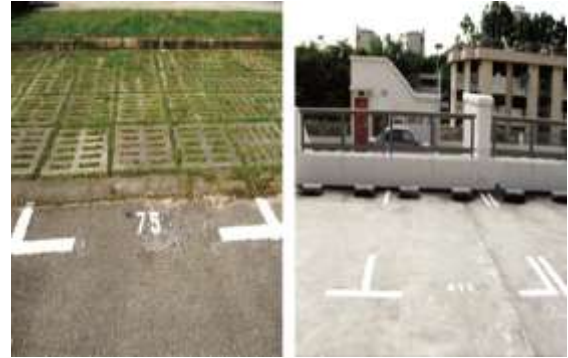

##### Lots Demarcated in White

- For car parks outside the Restricted Zone
- Coupon parking allowed
- Refer to signboard located at the car park for the coupon operating hours and parking charges



##### Lots Demarcated in Red and White (Bi-Coloured)

- Reserved for Season Parking Ticket Holders
- Coupon parking allowed during restricted hours
- Refer to signboard located at the car park for the coupon operating hours and parking charges



##### Lots Demarcated in Yellow

- For car parks within the Restricted Zone
- Coupon parking allowed
- Higher parking charges during certain hours
- Refer to signboard located at the car park for the coupon operating hours and parking charges

## PART C

### LANE USE AND VARIABLE MESSAGE SIGNS (LUS) / EMERGENCY FACILITIES (TUNNELS)

#### LANE USE AND VARIABLE MESSAGE SIGNS (LUS)

**247** Lane Use Signs are overhead signs in the KPE, CTE, MCE, Woodsville and Fort Canning tunnels which are used to inform motorists of any precautions to take prior to proceeding ahead on the lane. Each lane use sign will display either a green-down arrow, flashing amber cross or a red cross. A green-down arrow indicates that a motorist can drive on ahead; a flashing amber cross indicates that a motorist needs to drive with caution (e.g. obstructions on the lane ahead); and a red cross indicates that a motorist shall not proceed beyond the sign. Motorists travelling in the tunnel are to adhere to the displays shown on these overhead lane use signs.



**248** The Variable Message Signs on the road are used to disseminate traffic condition information to motorists.

There are various types of Variable Message Signs along the tunnels and at arterial roads leading to tunnels:

- (a) Entrance Variable Message Signs (EVMS): Located at the entrance of the slip road leading into the tunnel.



- (b) Arterial Variable Message Signs (AVMS): Located along an arterial road that leads to the entrance to the tunnel.



- (c) Tunnel Variable Message Signs (TVMS): An overhead sign located in the tunnel.

**249** For closure of the KPE, MCE and Woodsville tunnel, barriers and traffic signal controls at entry slip road approaches will be activated.

**250** Variable speed limit signs are also provided in the KPE and MCE tunnels. In smooth traffic conditions, the display on the signs will show a posted speed limit (with a red ring) that requires motorists' compliance. At times of congestion, recommended lower speed limits can be displayed (without a red ring) to smoothen out the flow, reduce the risk of flow breakdown and minimise the risk of accidents.

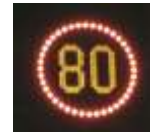

**251** KM markings are found on the vertical face of the kerb wall in the MCE, KPE and CTE tunnels to provide location referencing for the motorists



#### EMERGENCY FACILITIES

##### Exit

**252** Exit doors are located next to both the slow and fast lanes of the MCE, KPE and CTE tunnels.

**253** Escape Staircase doors - These exit doors next to the slow lanes can generally be found at intervals of **500m** in the main tunnel. There are also exit doors along the slip roads. These exit doors lead to escape staircases which open up to surface roads or open areas.



**254** Cross-passage doors - These exit doors next to the fast lanes are located at intervals of **100m** in the main tunnel and they lead to the opposite-bound tunnel.

**255** During an emergency, additional flashing lights at the doors will be lighted up to alert motorists of the emergency situation and the need for evacuation, and to draw their attention to the exit locations.



CTE Escape Staircase Doors

CTE Cross Passage Doors

##### Communication (OCC - Operations Control Centre)

**256** Emergency telephones are provided in the tunnel next to the slow lane at approximately 100m intervals.

**257** Each phone also has an amber light next to it that can be switched on to indicate to the motorist the OCC's intention to communicate with him/her in the MCE and KPE tunnel. The motorist can pick up the phone set to speak to the OCC.



Emergency (SOS) Phone



## PART C

### EMERGENCY/INCIDENT PROCEDURES (TUNNELS)

**258** Radio break-in is an important tool for the OCC to communicate with motorists in the tunnel during an emergency and as a good driving habit, motorists are encouraged to tune into an FM radio channel before entering the tunnel.

#### Fire Protection

**259** Portable fire extinguishers are also provided in the emergency cabinet which is available at 50m intervals along the tunnel. Motorists can make use of the fire extinguishers to put out any small scale fire in their vehicles.

**260** MCE and Woodsville tunnels are equipped with a water-based firefighting system. This is an overhead water sprinkler system that helps suppress fire growth rates to further protect major structural tunnel elements and minimise the potential impact of a fire.

**261** Coupled with the ventilation system present in all our road tunnels, the water-based firefighting system enhances the overall incident management process in the event of fire



### EMERGENCY/INCIDENT PROCEDURES

**262** For Motorist Whose Vehicle Is Broken Down

- (a) Switch on vehicle hazard lights.
- (b) When possible, drive onto the road shoulder and stop the vehicle.
- (c) The motorist can use the nearest emergency (SOS) phone (located next to the slow lane of tunnel) to contact the OCC for assistance. Alternatively, the motorist can dial 1800-CALL LTA (1800-2255582) for assistance.
- (d) LTA EMAS vehicle recovery service crew will arrive at the incident site to tow the stalled vehicle to the nearest designated car park.

**263** For Motorist Who Meets With An Accident

- (a) If there is neither injury nor serious damage caused to the accident vehicles, motorists involved in the accident are advised to drive out of the tunnel (especially for accidents which occur in the tunnel) and discuss all details pertaining to the accident at a safe location e.g. public car park.
- (b) If there is injury, or if an accident vehicle cannot be moved, motorists can use the nearest emergency (SOS) phone (if the accident occurs in the tunnel) to contact the OCC for assistance. Alternatively, motorists can dial 1800-CALL LTA (1800-2255582) or 995/ 999 for assistance.
- (c) LTA EMAS and SCDF/Traffic Police response teams will arrive at the incident site to assist the motorists.

**264** For Motorist Whose Vehicle Is On Fire

- (a) Use the manual call point to sound an alarm and wait for help.
- (b) Use the portable fire extinguisher inside the emergency cabinet to attempt to extinguish the smoke if the situation appears manageable.
- (c) Dial 1800-CALL LTA (1800-2255582) or use the nearest emergency (SOS) phone to contact the OCC for assistance. Alternatively, the motorist could contact the OCC immediately.
- (d) LTA and SCDF/Traffic Police response teams will arrive at the incident site to assist the motorist.

**265** For Motorist Who Encounters A Tunnel Emergency Eg. Fire in Tunnel

If you are in the tunnel:

- (a) Listen to any of the local radio channels for LTA emergency announcements and instructions.
- (b) Look out for the lane use signs.
- (c) If you cannot proceed, do not attempt to reverse your vehicle; turn off your engine and leave your vehicle. Proceed to the nearest exit or escape route to leave the tunnel immediately.
- (d) Do not be alarmed if the overhead water sprinkler system (water-based firefighting system) is activated (MCE and Woodsville Tunnel only).



**PART C**  
**EMERGENCY/INCIDENT PROCEDURES (TUNNELS)**

**266** Escape Route:

- (a) **Fort Canning Tunnel (FCT)** and **Woodsville Tunnel (WVT)** - head for the **tunnel entrance or exit**, whichever is safer.
- (b) **CTE** - head for the **escape staircase and cross passage doors** within tunnels with walls painted with red and white stripes.
- (c) **KPE/MCE** - head for the **white escape doors with green walls** within tunnels.



**FCT/WVT** - In an emergency, when you see flashing from the red coloured beacon lights mounted on the wall next to the service cabinets, leave the tunnel immediately

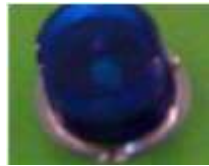

**KPE/MCE** - Strobe light mounted next to the escape staircase and cross passage doors



**CTE** – Strobe light mounted above door



Escape Staircase



Cross Passage Door



**KPE/MCE:** In an emergency, look out for white escape staircases and cross passage doors with green walls and identified by flashing bluish-white strobe lights Escape Staircase Cross Passage Door

**CTE** – In an emergency, look out for escape staircase and cross passage doors identified with flashing strobe light

**267** If you are approaching the tunnel:

- (a) Do not enter the tunnel.
- (b) Look out for the messages displayed on the Variable Message Signboards.
- (c) Use an alternative road to reach your destination.



## PART C

### ECO-DRIVING: WAYS TO SAVE FUEL AND SAVE THE ENVIRONMENT

#### INTRODUCTION

268 How you drive and treat your vehicle can have a significant impact on fuel consumption and emissions. Practicing eco-driving can reduce fuel consumption by up to 10% on average over time<sup>1</sup>. By observing just a few simple eco-driving steps, you can **reduce fuel use** and at the same time **reduce vehicular emissions**. This lets you play a part in **saving the environment** while **saving money!**

#### What is Eco-Driving?

269 Eco-driving generally refers to the practice of handling one's vehicle in a manner that promotes fuel economy and reduces emissions. These include vehicle maintenance, on-road driver behaviour, and route selection.

#### How to ADOPT Eco-DRIVING

270 Eco-driving is not difficult. You can lower your vehicle's fuel consumption and impact on the environment by observing these simple driving practices:

(a) Don't Leave Your Vehicle Engine idling

- (i) Turn off the engine when your vehicle is stationary for reasons other than traffic conditions. Idling engines waste fuel, generate unnecessary pollution to the environment, and cause fumes and noise nuisance to the public.



Do not idle your vehicle's engine

Note: Under the Environmental Protection and Management (Vehicular Emissions) Regulations, it is an offence to leave the vehicle engine running when it is stationary for reasons other than traffic conditions. Offenders are liable to a fine of up to \$5,000, if convicted in court.

- (ii) There is no need to warm up the engine before driving off. Modern engines reach their optimal temperature faster when the vehicle is driven at moderate speeds upon starting.

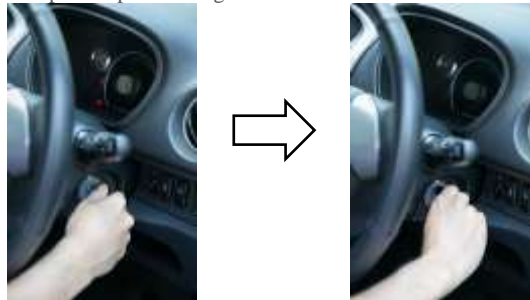

Turn off the engine when your vehicle is stationary

(b) Maintain Your Vehicle Regularly

- (i) Service your vehicle regularly. A well maintained vehicle is more fuel efficient and emits less pollution on the road.
- (ii) Check your vehicle's tyre pressure at least once a month. Correctly inflated tyres help reduce drag, improve fuel economy and reduce pollution. So make sure your tyres are at their recommended pressure.
- (iii) Avoid over-loading your vehicle. Carrying excess weight in a vehicle increases fuel consumption and emissions. Heavy or large items, e.g. heavy tool kits, etc., should be removed from your vehicle when not required.



Ensure that your vehicle's tyres are correctly inflated



Carry only what is necessary; avoid unnecessary weight

<sup>1</sup> Kojima, K., & Ryan, L. (2010). Transport Energy Efficiency: Implementation of IEA Recommendations since 2009 and next steps (No. 2010/9). OECD Publishing.

## PART C

### ECO-DRIVING: WAYS TO SAVE FUEL AND SAVE THE ENVIRONMENT

---

(c) Drive Smoothly

- (i) Avoid dragging the engine by using the correct gear if you drive a manual vehicle. Driving the vehicle in the right gear will increase fuel efficiency and reduce emissions.
- (ii) Drive at a steady speed and avoid unnecessary acceleration or braking as much as possible. Avoiding unnecessary acceleration Maintain a and heavy braking helps reduce your vehicle's fuel consumption.
- (iii) safe distance between your vehicle and the vehicle in front to avoid last-minute braking and to get up to speed as smoothly as possible.



Drive at a safe and steady speed

(d) Minimise Use of the Air-Conditioner While Driving

- (i) Avoid setting your vehicle's air-conditioning temperature too low and instead increase the fan speed in order to achieve higher fuel efficiency and reduce emissions. Air-conditioning consumes a lot of fuel to keep you cool!



Avoid setting your air-conditioning temperature too low

(e) Plan Your Journey

- (i) Plan your journey before setting off to avoid traffic congestion or getting lost on the roads. This can save you both time and fuel as well as reduce emissions.



Plan your journey

## **PART C**

### **SECURITY MEASURES TO PREVENT THEFT OF/FROM MOTOR VEHICLES**

---

#### **INTRODUCTION**

- 271** Motor vehicle theft (MVT) and theft from vehicle (TFV) are two of the Police's key crime concerns. The majority of these cases take place in carparks located in public housing estates.
- 272** Similar to past trends, theft of motorcycles continue to form the majority (about two-thirds) of all theft of motor-vehicles reported to the police. Joyrides and transportation for personal uses continue to be common motives for stealing such vehicles. However, some stolen vehicles are never recovered.
- 273** Likewise, for theft from vehicles, common items stolen, especially from cars, are laptops, handbags, cash cards and handphones. The culprit(s) usually smash the window or windscreen of the car in the dead of the night to gain access to the valuables left behind by the owner.
- 274** Therefore, it is every vehicle owner's responsibility to ensure the security of their vehicle and valuables kept within, in order to prevent such thefts from occurring. Future vehicle owners such as yourself, are encouraged to enhance the security of vehicles by taking adequate crime prevention measures.
- 275** The inconveniences and monetary loses caused to vehicle owners by such thefts are significant. You can prevent such unfortunate incidents by adopting the following simple measures:

#### **MOTORCYCLES**

- 276** (a) Remove the ignition keys and handle lock your motorcycle, even if you are leaving for a short while. It takes only a short time for thieves to strike;
- (b) Locking devices such as front wheel safety lock, handlebar lock, brake/disc lock and cable lock can be used to enhance the security of your motorcycle;
- (c) Use a motorcycle canvas to cover the vehicle, securing both ends with locks;
- (d) Consider fitting additional safety devices such as an alarm system and immobilizer for your motorcycle;
- (e) To prevent the motorcycle parts from being stolen, you may consider labelling security markings (e.g. the vehicle registration number) on major parts of the motorcycle or installing a device known as a suspension guard to prevent easy removal of the motorcycle's suspension;
- (f) Remove your cashcard from the IU when you leave your motorcycle.

#### **CARS**

- 277** (a) Remove the ignition key, wind up all the windows and lock all the doors whenever it is left unattended, even for a short while;
- (b) Do not leave valuables such as cash cards, briefcases, handbags, laptops or handphones exposed in your vehicle. If need be, such items should be kept out of sight or locked in the car boot;
- (c) Consider fitting additional safety devices such as an anti-theft alarm system or an immobilizer on your vehicle. An anti-theft alarm should be regularly checked/serviced to ensure its effectiveness;
- (d) Use an additional lock such as steering wheel lock, clutch & brake locks, gear lock, etc.;
- (e) Keep a record of the serial numbers of valuable items such as laptops, handphones (IMEI no.) and/or cash cards. These will help the police in investigations.

#### **GENERAL**

- 278** (a) Be wary of suspicious characters loitering around the carparks. If you see any person loitering around suspiciously, do not hesitate to contact the Police at '999';
- (b) Whenever possible, park your vehicle in a well-lit area. Avoid parking at dark or secluded areas;
- (c) Form a good habit of securing your vehicle. Always remember, "Lock, Look and Leave":
- (i) Lock your vehicle and ensure that all valuables are kept out of sight,
- (ii) Look around your car when parking. Whenever possible, park your vehicle in a well-lit area or prominent location where human traffic volume is high,
- (iii) Leave your car secured and with peace of mind;
- (d) Crime prevention is a shared responsibility. Crime can be prevented if owners and members of the public adopt measures to stay vigilant against criminal acts. Together, we can help make Singapore a safer home for all.

## PART C

### KEY POINTS OF THE MOTOR CLAIMS FRAMEWORK (MCF)

---

279 In the case of an Accident, you should *avoid all unauthorised tow-truck operators or repair workshops.*

#### Steps to take:

- 280 (a) Exchange particulars of involved parties (including **Name, NRIC/FIN, Telephone Number, Address and Insurer**);
- (b) Take note of the **Vehicle Numbers**;
- (c) **Take pictures at the accident scene** and submit all pictures at your authorised accident reporting centre during reporting;
- Things to Photograph:
- (i) The Scene (Take pictures of the accident scene capturing the accident vehicles and surrounding areas);
- (ii) Own Vehicle (Take pictures of the damage to your own vehicle, capturing your licence plate);
- (iii) Other Damaged Vehicles (Take pictures of damage to all other vehicles involved in the accident, capturing their license plates. For multiple vehicle collision, take pictures of the vehicles with direct contact, e.g. vehicles in the immediate front and immediate rear.)

281 **Call your insurer's hotline** for a tow truck or for further advice on the accident.

282 Report and bring your accident vehicle (whether damaged or not) to the approved reporting centre / authorised workshop **within 24 hours** or by the **next working day**.

#### The benefits of reporting:

283 By reporting the accident within the stipulated time, you not only enjoy hassle-free and quality-certified repair services as provided under the MCF, you will also avoid potentially higher costs from exaggerated claims.

- (a) **Remember** that all accidents must be reported to your insurer within 24 hours or by the next working day with your accident vehicle. Report the accident no matter how trivial or even if there is no visible damage, and irrespective of whether you are claiming from any insurers or third parties.
- (b) **Should you fail to report the accident** to your insurer with your accident vehicle, you may find yourself in a position of having your claims prejudiced or declined later by insurers. Failure to comply with this new policy condition will be seen as being "In breach" of the policy terms and conditions, i.e. there will be no liability on the part of the insurer. In addition, any non-compliance with this policy condition will result in a loss of your 'No Claims Discount' upon renewal of your policy.